



Perfect Appearance Excellent Performance

精 于 静 精 于 动

P51 D Mustang v8

OPERATING MANUAL

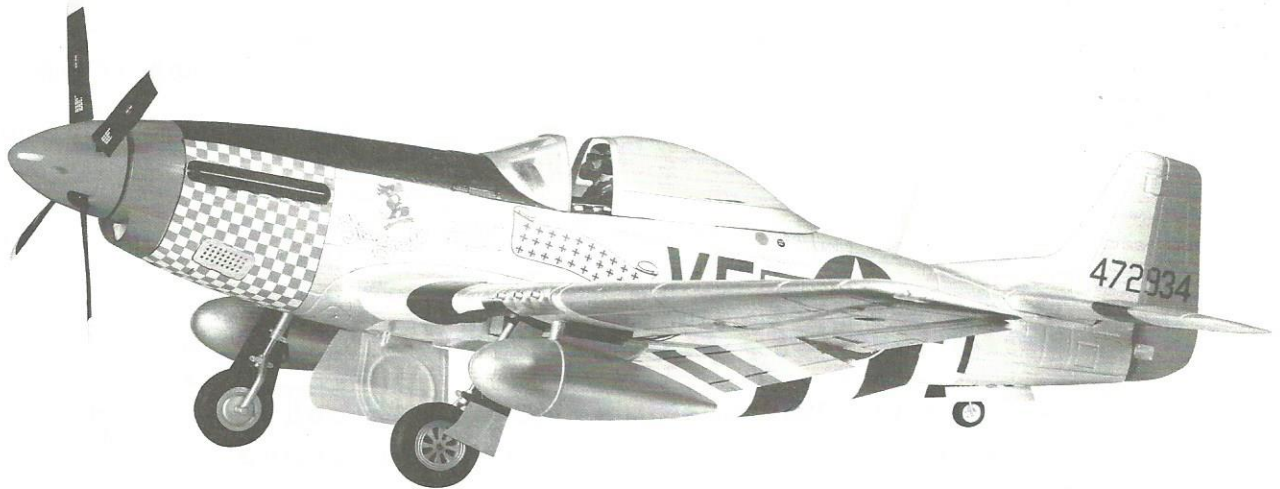

Please visit both our **Facebook** fanpage and our homepage for updated product information

WARNING

 **WARNING:** Read the ENTIRE instruction manual to become familiar with the features of the product before operating. Failure to operate the product correctly can result in damage to the product, personal property and cause serious injury.

This is a sophisticated hobby product and NOT a toy. It must be operated with caution and common sense and requires some basic mechanical ability. Failure to operate this Product in a safe and responsible manner could result in injury or damage to the product or other property. This product is not intended for use by children without direct adult supervision.

This manual contains instructions for safety, operation and maintenance. It is essential to read and follow all the instructions and warnings in manual, prior to assembly, setup or use, in order to operate correctly and avoid damage or serious injury.

Safety Precautions and Warnings

As the user of this product, you are solely responsible for operating in a manner that does not endanger yourself and others or result in damage to the product or the property of others. This model is controlled by a radio signal subject to interference from many sources outside your control. This interference can cause momentary loss of control so it is advisable to always keep a safe distance in all directions around your model, as this margin will help avoid collisions or injury.

Age Recommendation: Not for children under 14 years. This is not a toy.

- Never operate your model with low transmitter batteries.
- Always operate your model in an open area away from cars, traffic or people.
- Avoid operating your model in the street where injury or damage can occur.
- Never operate the model in the street or in populated areas for any reason.
- Carefully follow the directions and warnings for this and any optional support equipment (chargers, rechargeable battery packs, etc.) you use.
- Keep all chemicals, small parts and anything electrical out of the reach of children.
- Moisture causes damage to electronics. Avoid water exposure to all equipment not specifically designed and protected for this purpose.
- Never lick or place any portion of your model in your mouth as it could cause serious injury or even death.

FMS Kindly Reminder



Thank you for purchasing a FMS model product. Our goal is to provide high quality products and offer great customer service. If you have any problems with your product or want to offer suggestions for improvements (such as plane design, packaging, building instructions, etc.) please feel free to contact us at info@fmsmodel.com

The control horn installation

1. The control surface horns for the rudder and elevator are stapled to the bags containing the rudder and elevator, do not accidentally discard them.

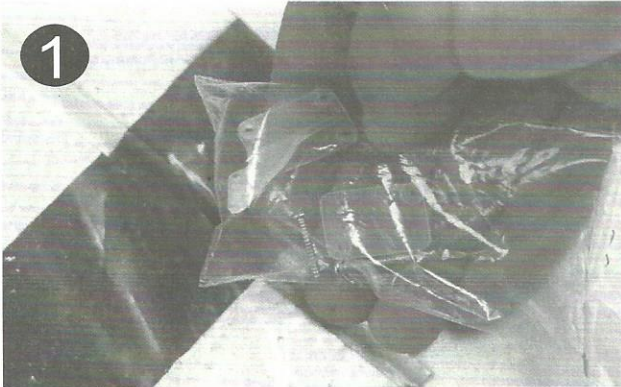

2. Install the elevator control surface horns on the bottom of the elevator surface with the screws provided in the small plastic bag. The side of the stabilizer that contains the nose faces down, make sure to install the control horns on this side. Make sure the control surface horns are facing into the right direction before installing.

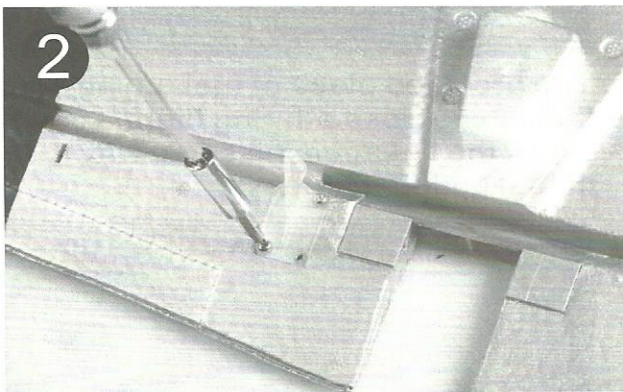

3. Always make sure that the screws are grabbing into the back plates of the control horns. It is very important that these parts are holding tight during flight.

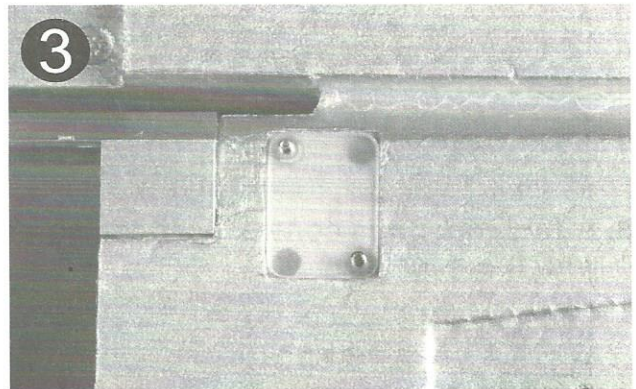

4. Attach the rudder surface control horn to the port side of the rudder.

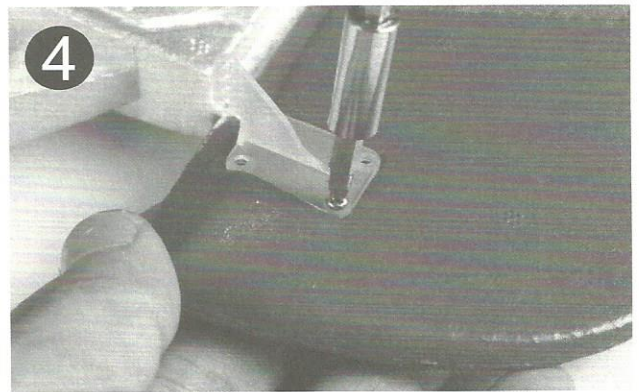

The control horn installation

5. Now attach the aileron surface control horns to the bottom of the lower main wing.

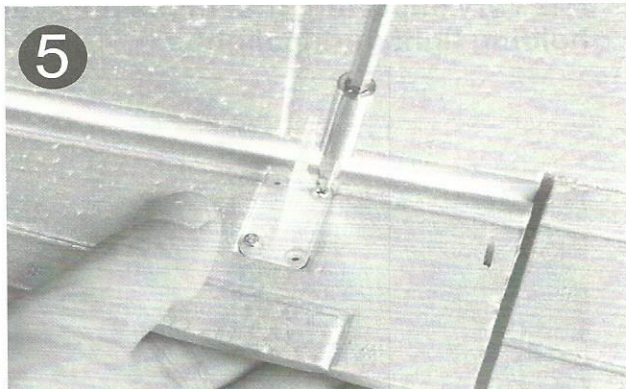

6. Attach the flaps control horn the same with the aileron .

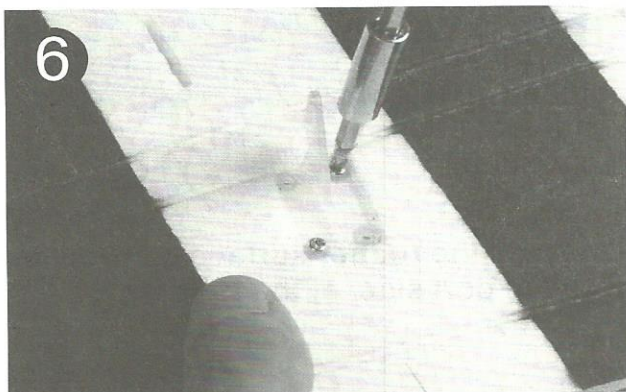

The control rod linking

1. Put the Z-bend end of the linkage into the desired servo control horn hole of the main-wing.
It is a tight fit and should allow the linkage to move just slightly within the hole to avoid binding up.

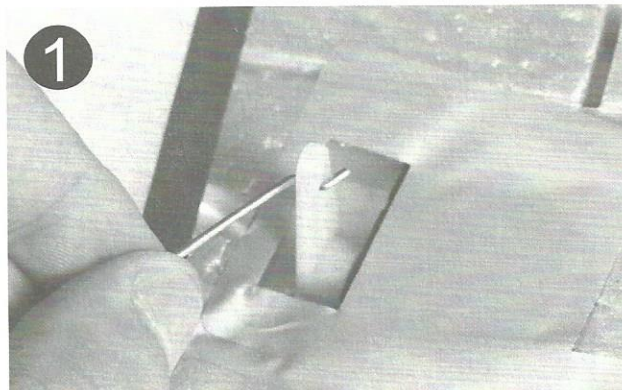

2. Slap the clevis into the surface control horn.

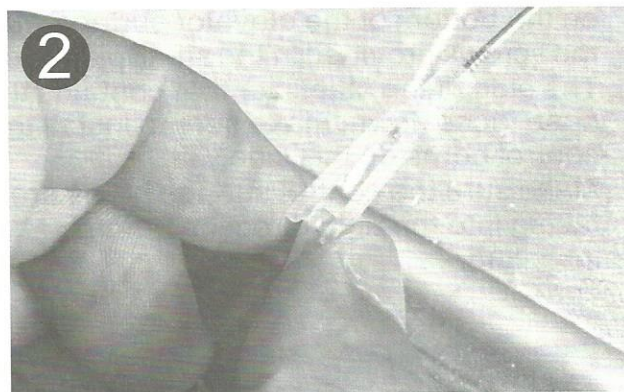

3. The provided piece of fuel tubing keeps the clevis closed during flight.
Do all the linkages the same way in the model building process.

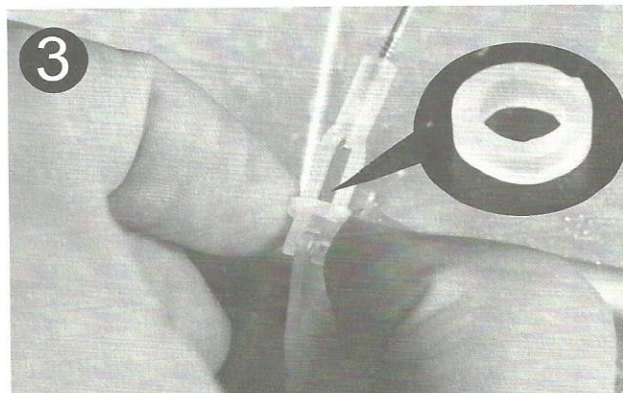

One piece main wing building

1. Insert the in stored fiberglass tube into the main wing trailing edge side socket.
Note: When sliding the tubes into the wings, they should go in easily. Do not push them farther than they will go with little resistance. That would push the wing tubes into the foam of the wing and prevent them from fully inserting into the opposite wing half. Insert the connecting tube till the white mark the factory pre spackled.

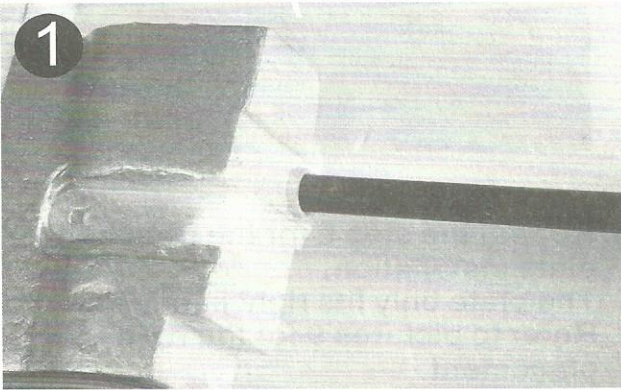

2. Insert the in stored pre bended Aluminium tube into the main wing leading edge side socket till the bend point.

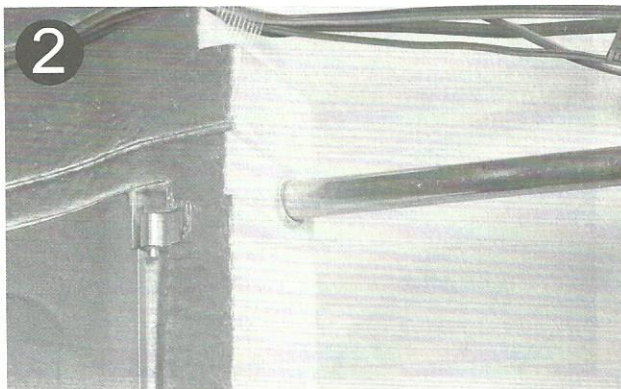

3. The two rods are parallel from the top view.
Note: the bended angle of the rod consistent with the main wing dihedral.

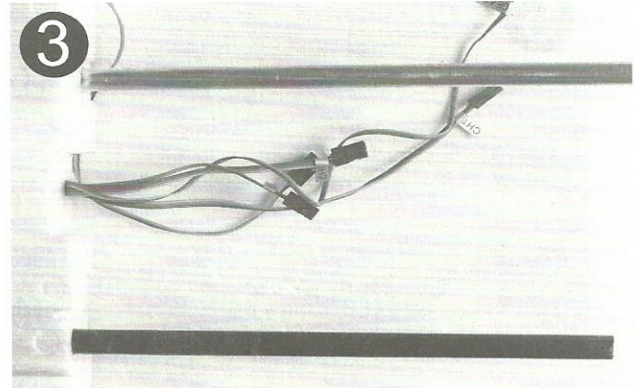

4. Connect the rest half wing to the rods, slide it in slightly. Make sure there is no slot between this two main wing panels. If not, you have to check the obstruction out.

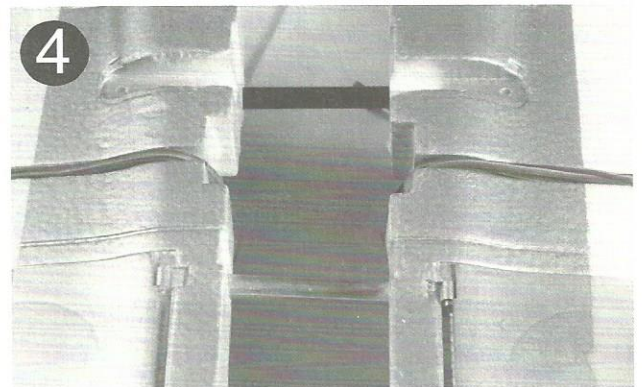

One piece main wing building

5. Apply appropriate amount of glue on the temporary glue tray, we recommended use disposable card paper.

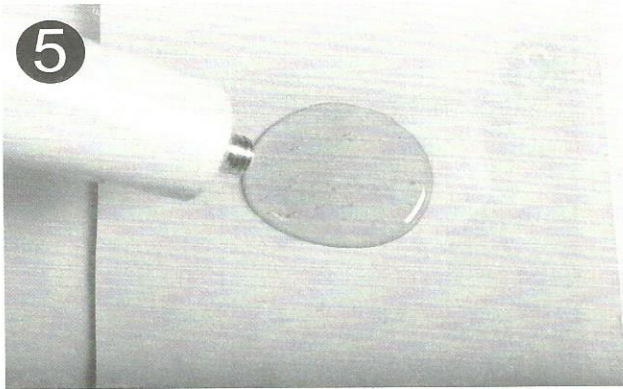

6. Use a small amount of glue and make it well distributed for attaching the rear lower wing bolt plate.

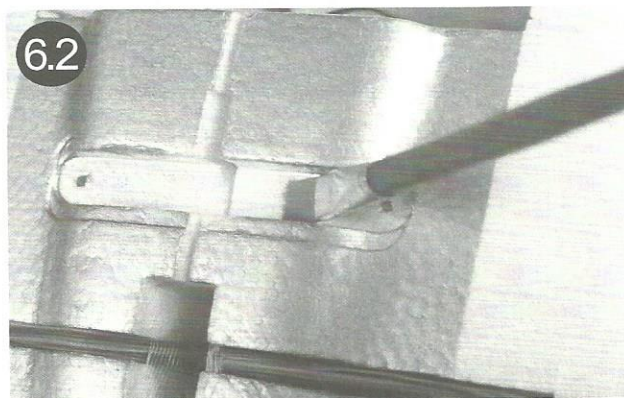
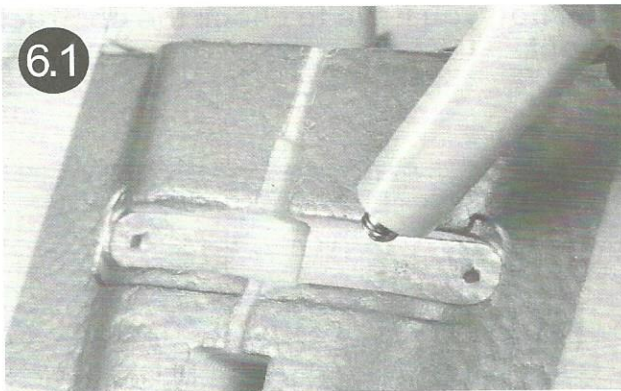

7. Make sure that you place the plate into the notch correctly.
The plate only fits right in one direction.

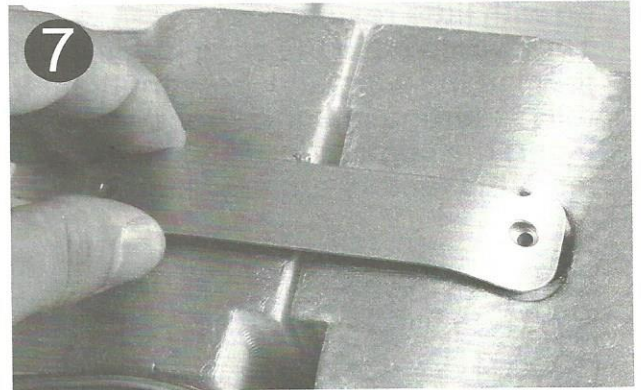

8. Repeat the step 6 for the front bolt plate installation.
The plate only fits right in one direction.
Refer to pictures 9 for the right placement.
Plate mounted the wrong way round.
The plate will not fit into the notch if you try to mount it as shown in the picture.

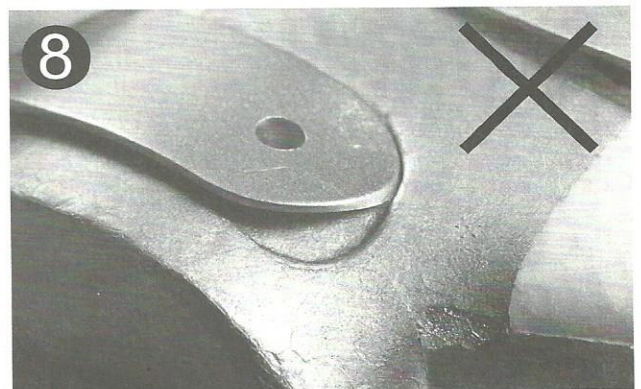

One piece main wing building

9. This is how the plate should be mounted.

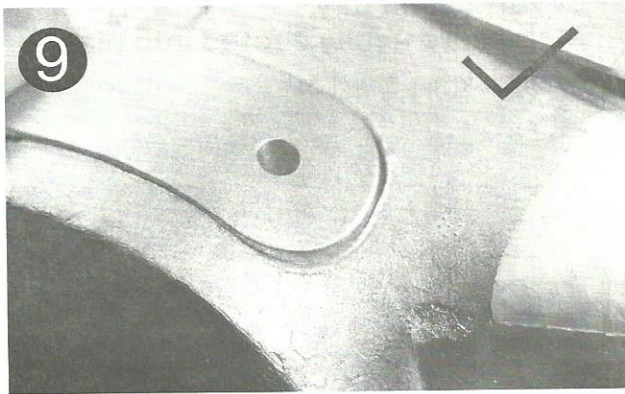

10. Place the two inner fairing door servo leads in the slot between the two main wing panel, and stream them with the other leads.

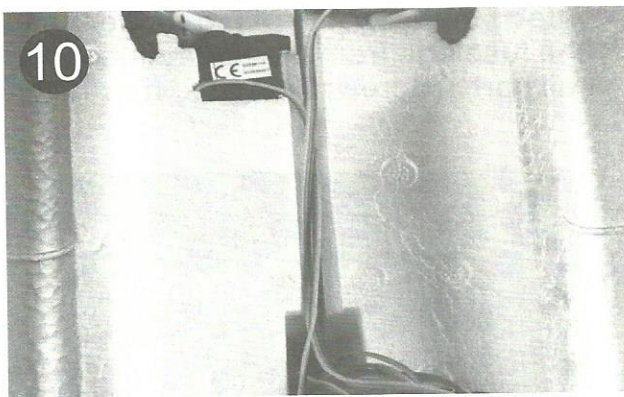

11. Make sure fix the wire leads in the slot with the clear tape or glass fiber tape.

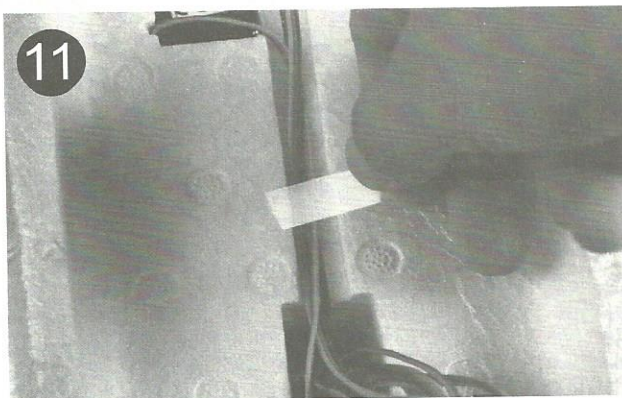

Install the stabilizer

1. Fix the horizontal stabilizer into place with the nose insert into the fuselage slot. Make sure it fully seated into place.

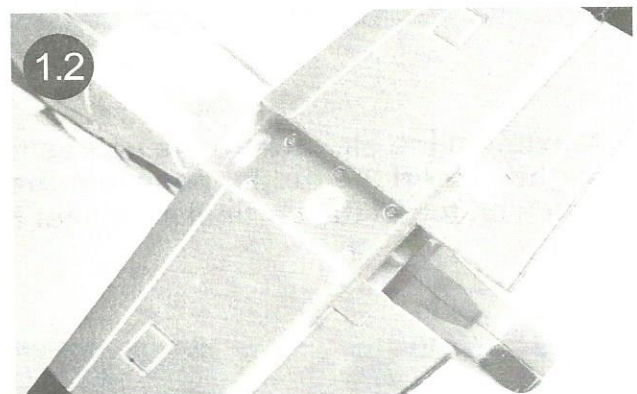
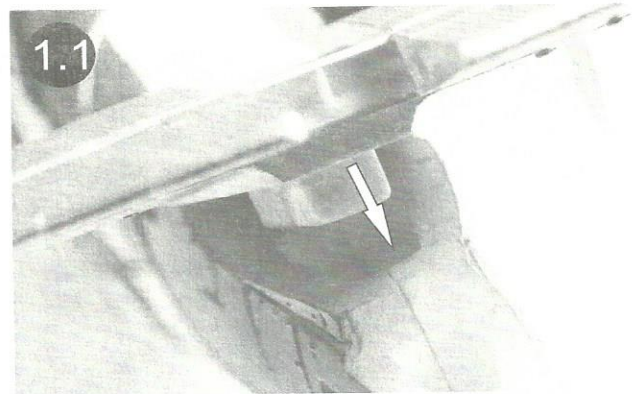

2. Secure the rear side of the stabilizer using the provided screw. (PA 2.6*25 1PC) Do not over tighten the screw, but make sure it's tight enough. There is another screw on the leading edge side of the stabilizer, we preserve it to the **Control surface testing and setting** step(Page 14) to secure it.

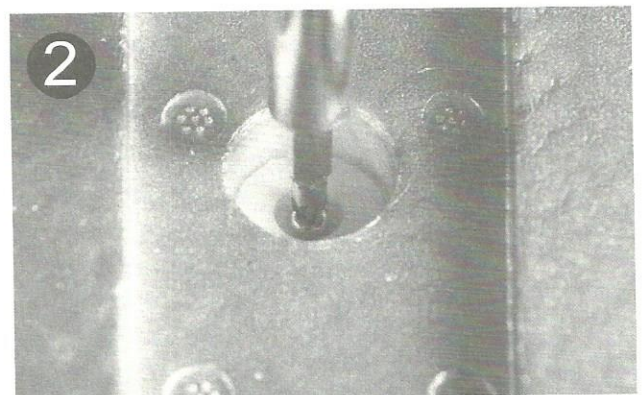

Install the stabilizer

3. Fix the Vertical stabilizer into place with the nose insert into the fuselage slot make sure it fully seated into place.

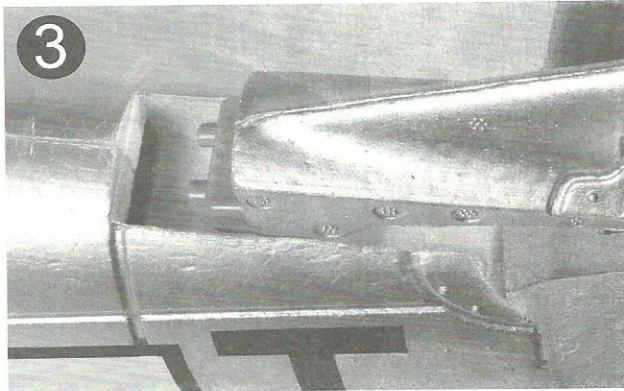

4. Maximum the elevator to the up position, slightly insert the rudder nose into the notch on top of the vertical stabilizer bay.

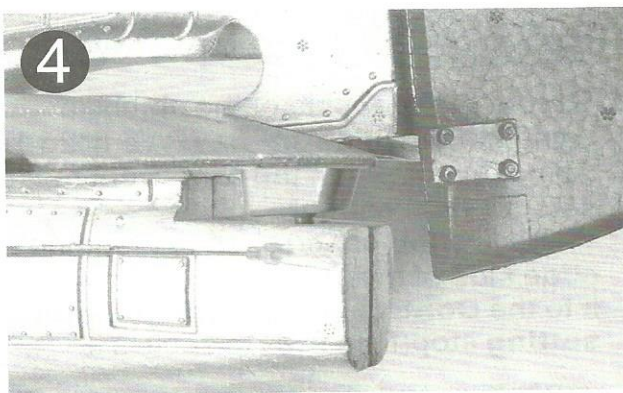

5. Slide the vertical fin forward make sure the nose insert into the notch in front of vertical fin bay. Make sure it fully seated into place.

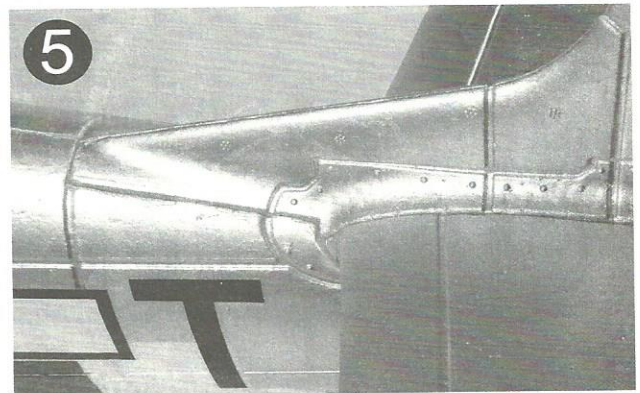

6. After fitting the rudder into place properly, use the provided self tapping screw to attach the rear side of the rudder fin to the fuselage from the underside of the tail part. (Screw: PA2.6X25mm 1PC)

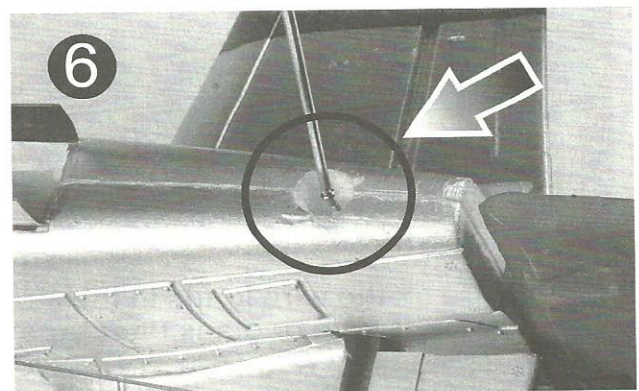

Mount the main wing

1. The left and right wing filler.

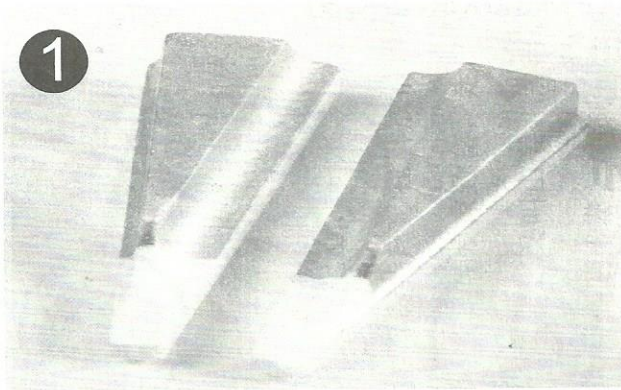

2. Fit the wing filler into place rightly.
The filler mounted the wrong way round.
Note: If the filler mounted the wrong way into the notch it will not perfectly fitted into place.

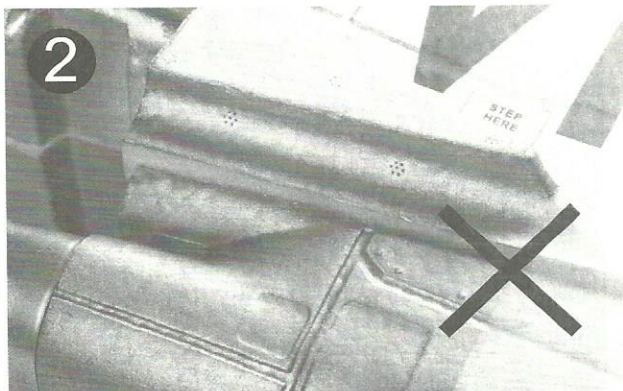

3. The filler mounted the right way.



4. Take the filler out and glue it back where you fitted it.

Note: Apply glue on where the filler and the fuselage fitted together.
Seat it into place as soon as the glue apply completed since the resistance will increase badly when the glue getting dry.
Repeat the same step for the other filler install.

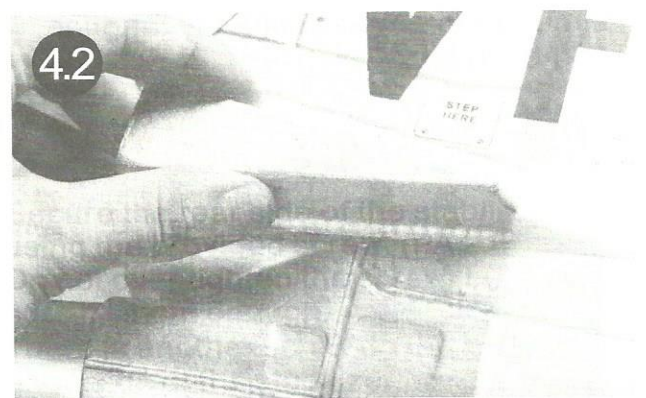
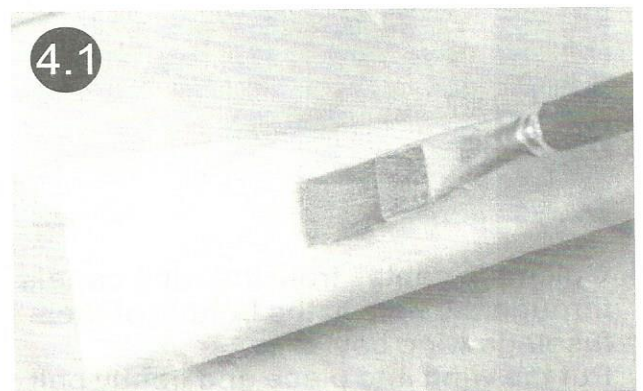

Mount the main wing

5. Mount the wing to the fuselage by fitting the rear side of the main wing to the groove under the air cooling intake vent.

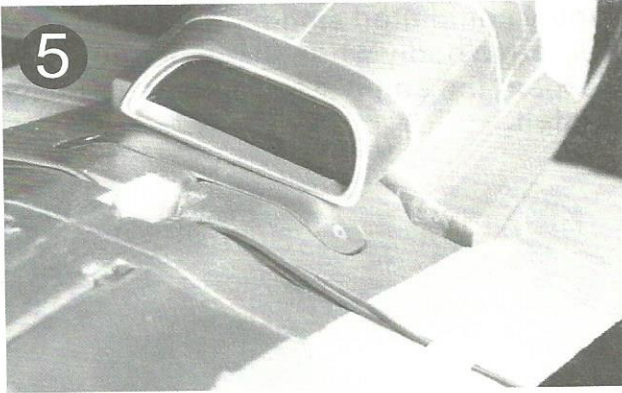

6. Guide the cables from the wing panels through the hole in the bottom of the fuselage wing bay. Put the wing into place and gently pull the cables from inside of the canopy simultaneously to avoid any tangling of the cables.

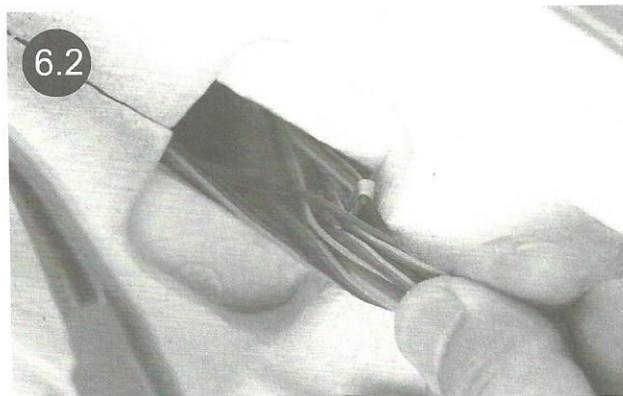
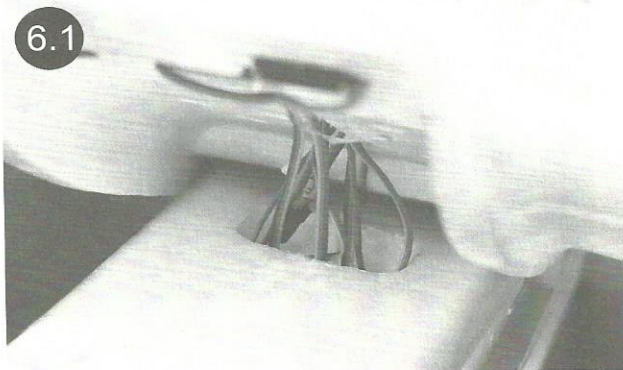

7. Secure the rear main wing bolt plate using the provided machine screws. (PM 3.0X60 2PCS)

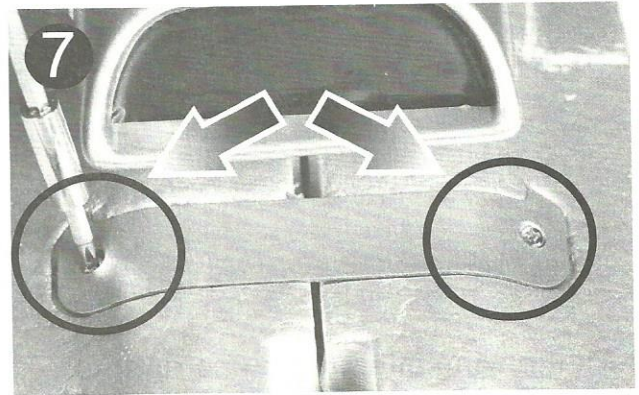

8. Secure the front main wing bolt plate using the provided machine screws. (PM 3.0X45 2PCS)

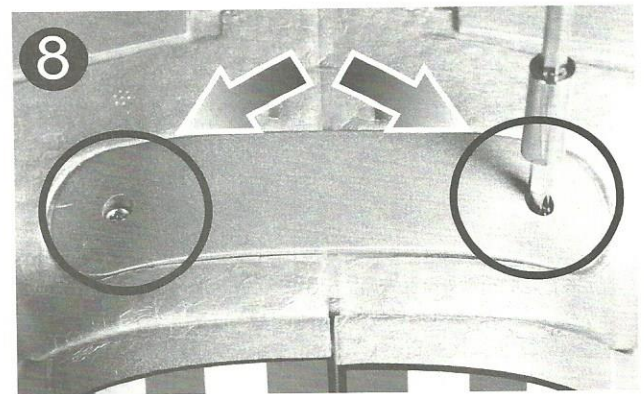

Install the propeller blades to the backplate

1. The propeller and the spinner kit.

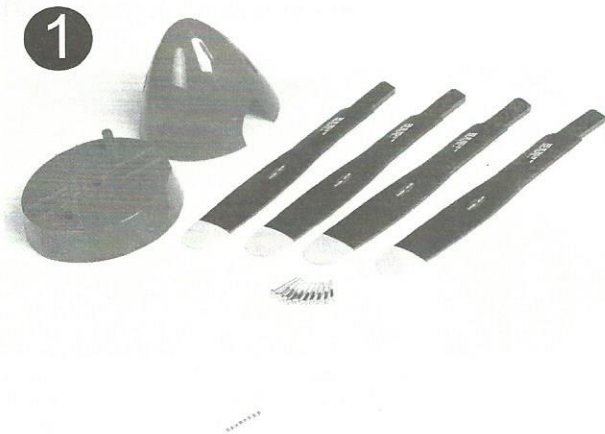

2. Place two self-locking nuts rightly into the hex notch on bottom of the spinner back plate.

Note: Always use a piece of scrapped board (laminated board, plastic or metal board) hold the nuts into place in the process of the blades mounting.

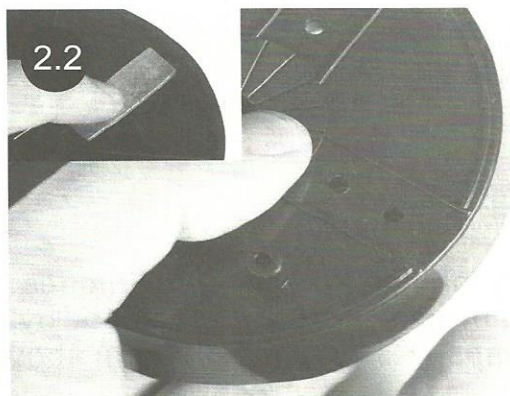

3. Take one of the propeller blades and properly fit it into the corresponding notch on top of the spinner backplate. Make sure that the paint side of the blade faces the right direction. Attach the blade to the spinner backplate with two machine screws. (Screws: PM3.0x18 2PCS)

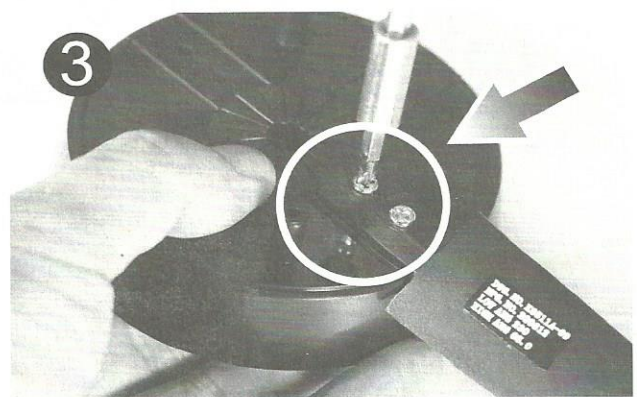

4. Repeat the steps (2&3) for the other three propeller blades mounting.

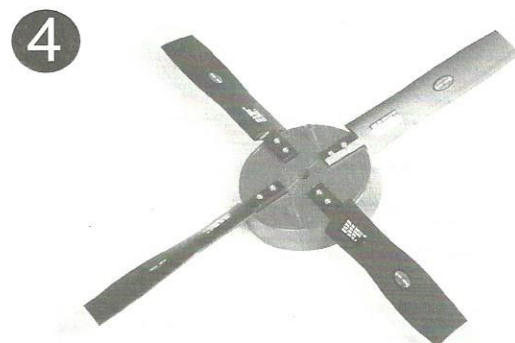

Wire connection

Connect the multiple connector of 1400MM P-51D

1. Insert the plugs from one of the wing panel to the multiple connector **Part 1** with the signal wire (The orange and/or the white cable) toward the channel label side.

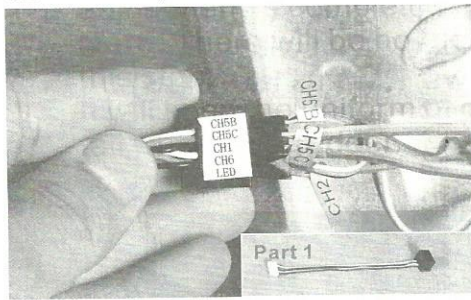

2. Fix the wire into the slot using the tape as the picture shows.

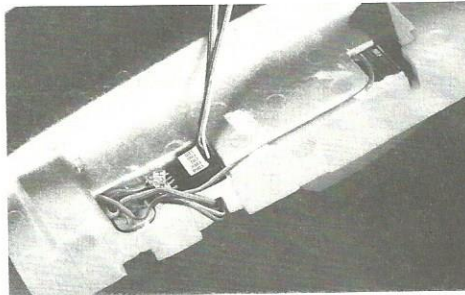

3. Connect two pieces main wing panel together.

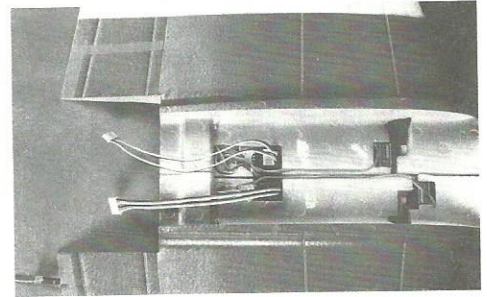

4. Insert the Multiple connect **Part 1** to **Part 2**

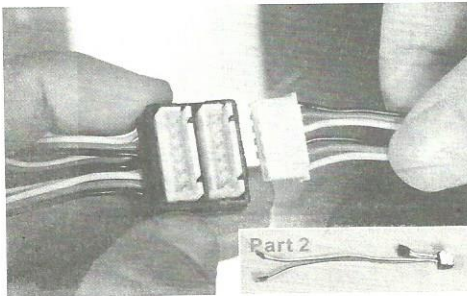

5. The Multiple connect **Part 2**, Ch1 and Ch6 to the receiver, and Ch5 B Ch5 C to the sequencer in step 6.

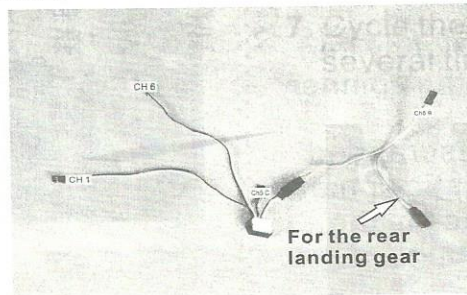

6. Plug the leads Ch5 B and Ch5 C to the sequencer as the picture shows with the chip side of the PCB faces up. Insert the sequencer to the gear channel.

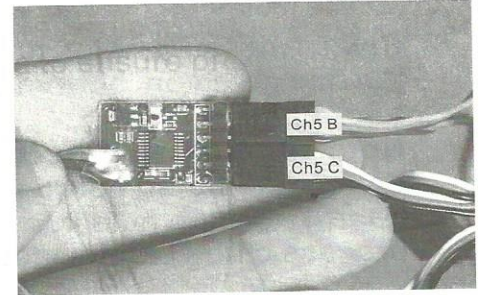

Note: Please insert the leads correctly into the receiver for the proper operation of your model. This connector can make you manage your cable better with out any hassle.

1. The receiver connection

2. Diagram for the sequencer connection.

Note: With the top side of the sequencer face up. Ch5 B for the retracts Ch5 C for fairing door driving servos. The signal wire of the leads (The orange wires) on the same side.

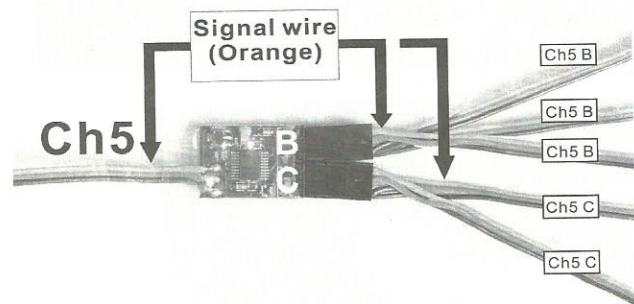
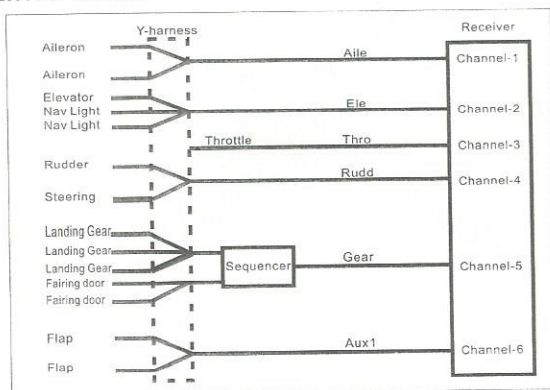

Note: All servo and retract leads have been specifically labeled for your convenience. Use the provided Y-harness for situations where two or three servos are controlled by one channel; for example ailerons, landing gear, and flaps. Refer to the diagram above for recommended connections.

Control surface testing and setting

1. The battery hatch locates in front of the canopy bay.

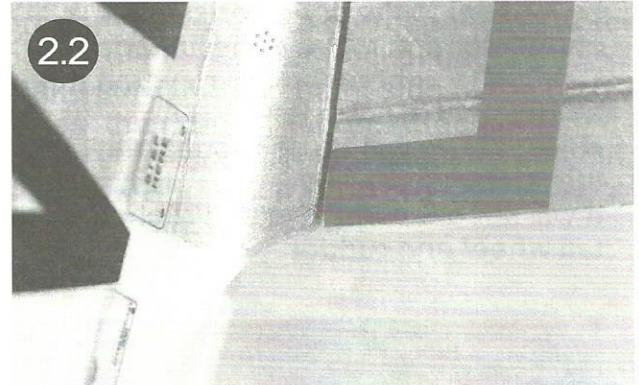
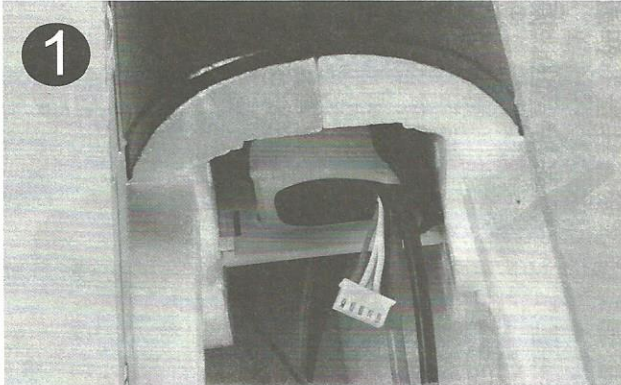

2. Before getting started, bind your receiver with your transmitter. Please refer to your Transmitter Manual for proper operation.

CAUTION: To prevent personal injury, DO NOT install the propeller assembly onto the motor shaft while testing the control surfaces.

Make sure all control sticks on your radio are in the neutral position (rudder, elevator, ailerons) and the throttle is in the OFF position.

All servos have been factory set to the neutral position. Thread the clevis on the linkage rods for each aileron and adjust the clevis so that the control surface aligns with the trailing edge of the wing tip.

Note: Please secure the clevis to the control horn when the adjustment is complete.

3. Adjust the clevis to make the ailerons align with the trailing edge of the flap.

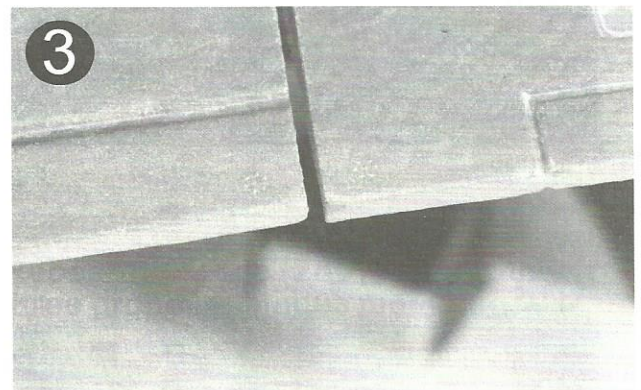

4. Adjust the rear landing gear direction by trim the rudder channel. Make sure the wheel align with the fuselage centerline.

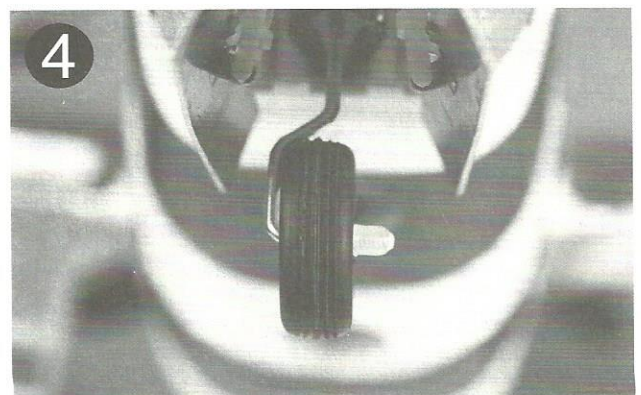
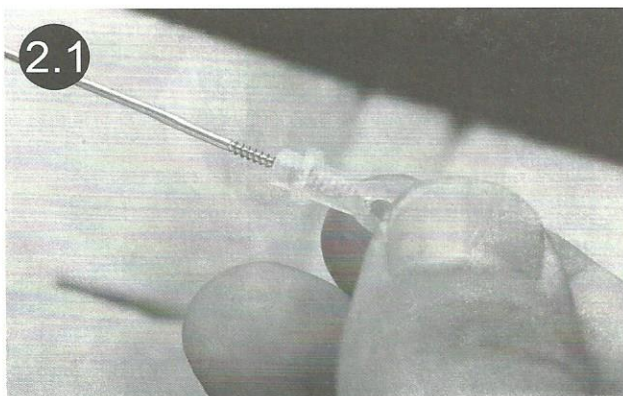

Control surface testing and setting

5. Set the rear landing gear neutral position by loosening the screw on control connector and moving the linkage rod. Be sure to tighten the screw when the adjustment is complete.

Note: There will be no rudder trim used in this step.

It will keep the uniform of direction of the tail wheel and rudder.

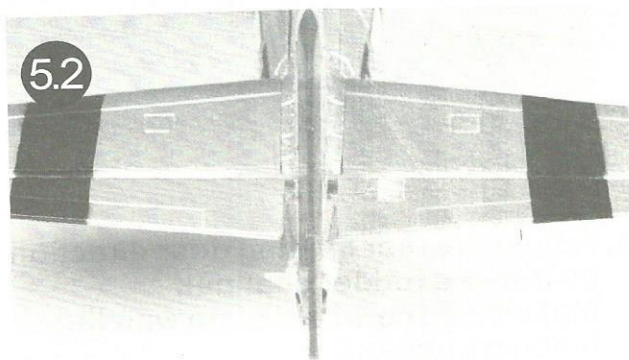
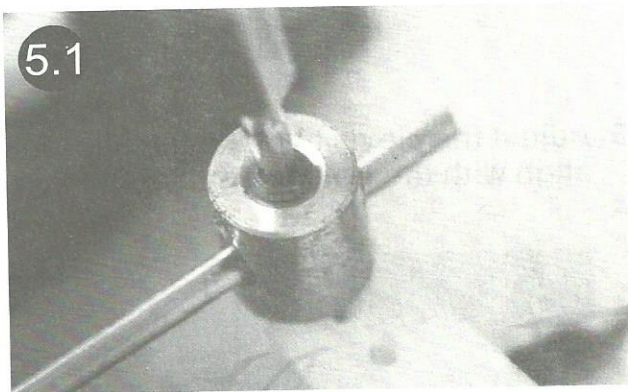

6. Adjust the elevator linkage rod the same with rudder.

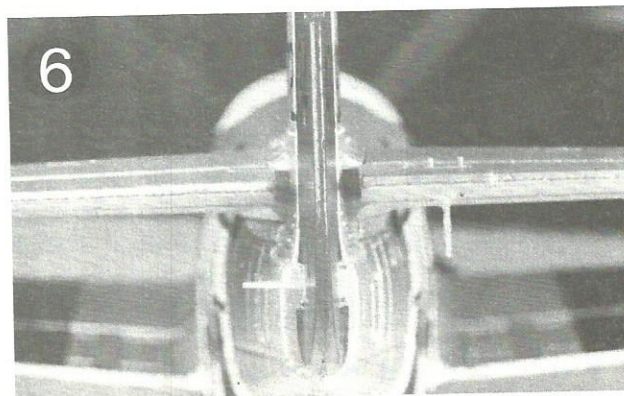

7. Cycle the retractable main landing gears several times to ensure proper function.

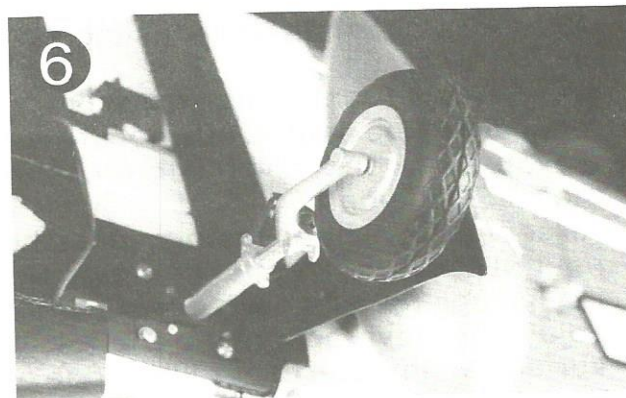

8. Test the motor make sure it is responsive to the throttle input and rotate the clock wise from the tail view, or you have to reset the throttle.

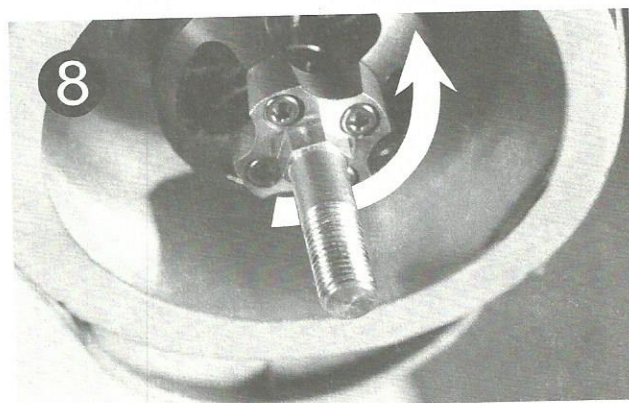

Control surface testing and setting

9. Keep the landing gear in low position. Use a magnetic screw driver to secure the provided screw on the rear part of the gear hatch to secure the leading edge side of the elevator. (PA 2.6X20MM 1PC)

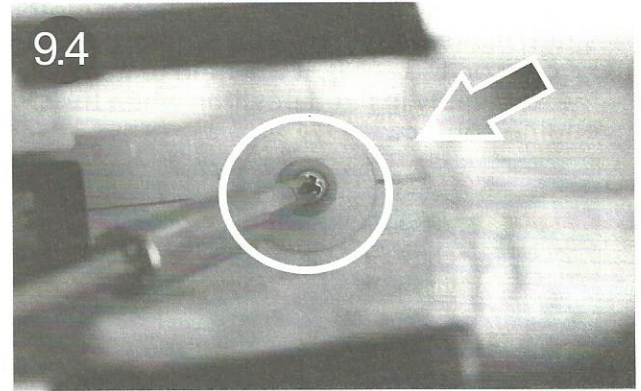
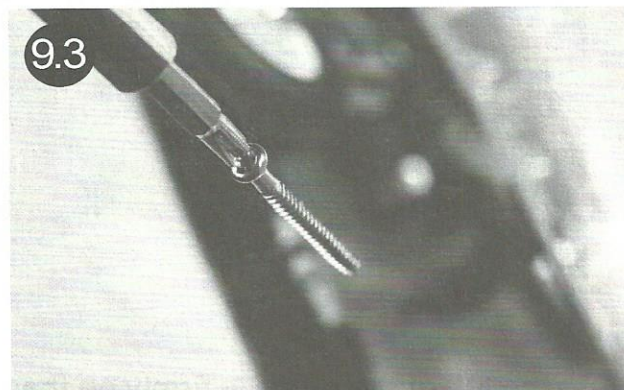
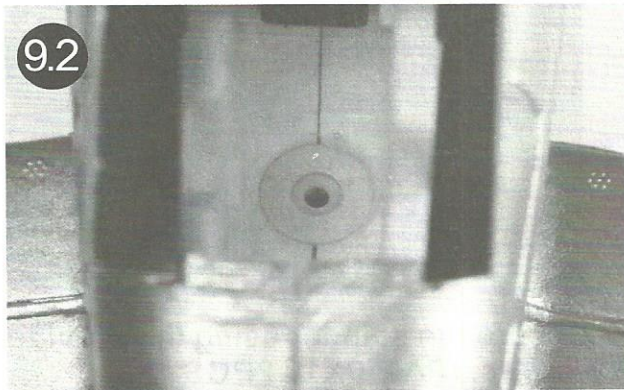

10. Apply glue on the combined side of the air exhaust stack.

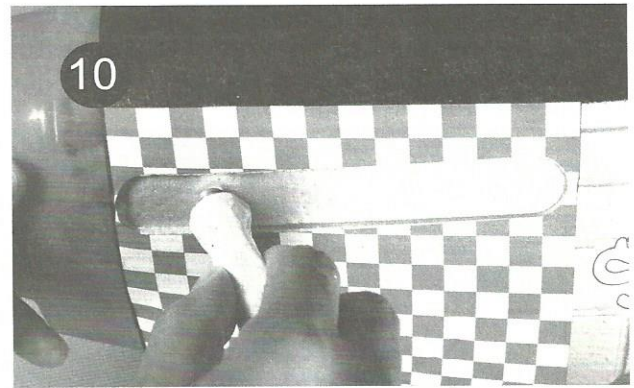

11. Install the air exhaust stack. Note: Insert the front part of the stack into the concave part of the cowl.



Install the propeller assembly

1. Keyed the propeller assembly to the motor shaft, make sure to fit the assembly into the hex nut on the shaft, it will help to hold the assembly in fixed position when the engine contact.

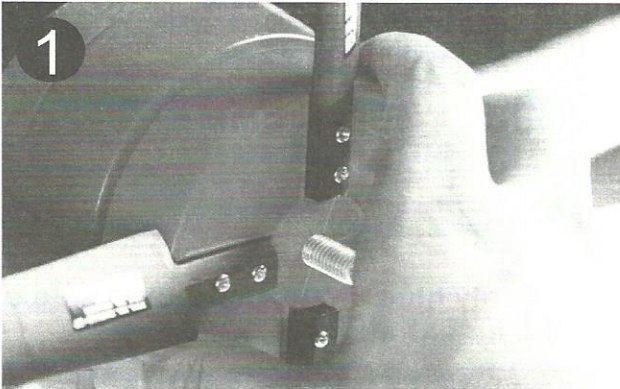

2. Take the washer and thread it to the motor shaft, it will help to prevent the propeller holder from the nut scrape.

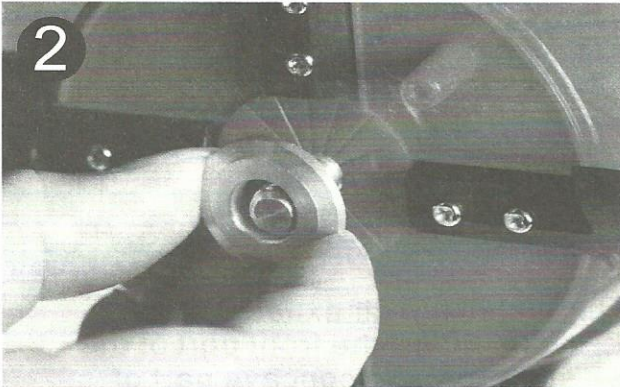

3. Secure the propeller by tightening the nut use the screw driver, do not over tighten, but make sure it's tight enough.

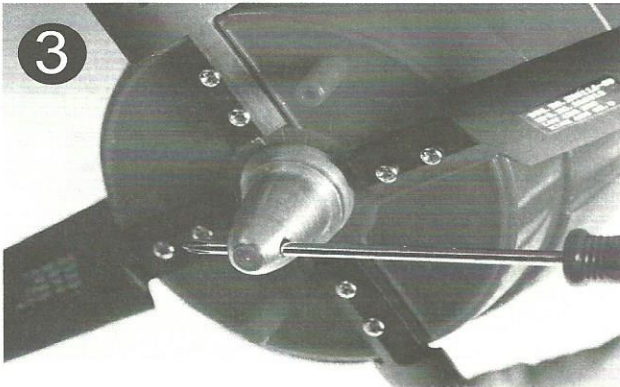

4. Rightly fit the spinner into place, make sure the holes in the spinner perfectly matched with the dowel on the backplate that hold the screws into place.

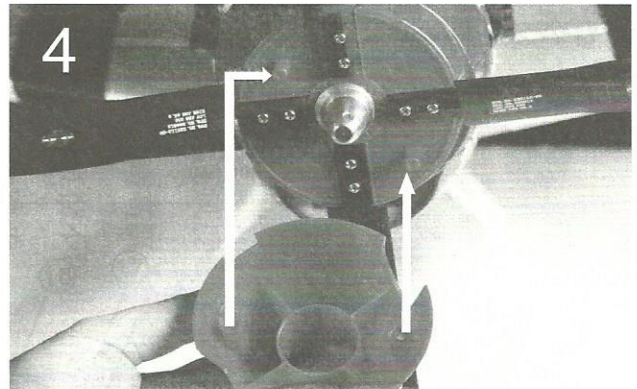

5. Fit the spinner into place.

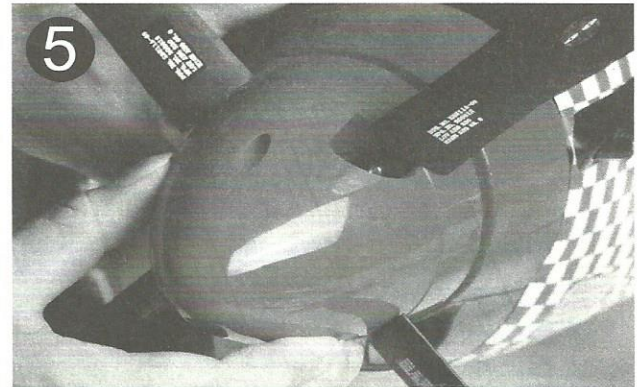

6. Secure the spinner using the provided screws. (PA 2.6X10 2PCS)

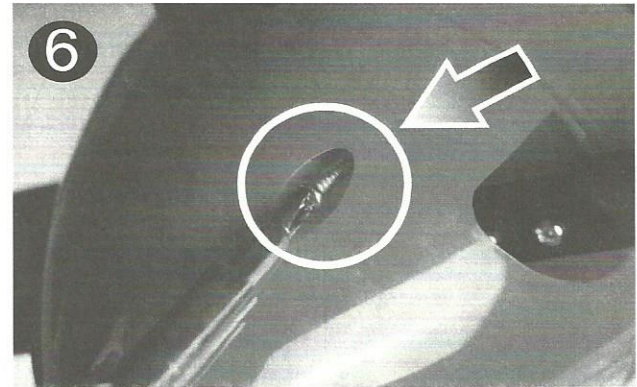

CAUTION: Before testing the propeller, make sure the tail of the plane is firmly on the ground and ensure there are no people or objects in the range of the propeller. Make sure the throttle stick and the trim on the lowest position before plug in the battery.

Install the accessory parts of the plane

1. Install the antenna by applying appropriate amount of glue in the slot pre-notched for the antenna using the toothpick.

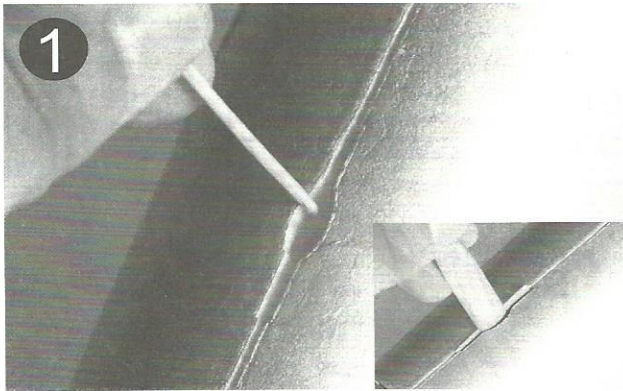

2. The machine gun set.

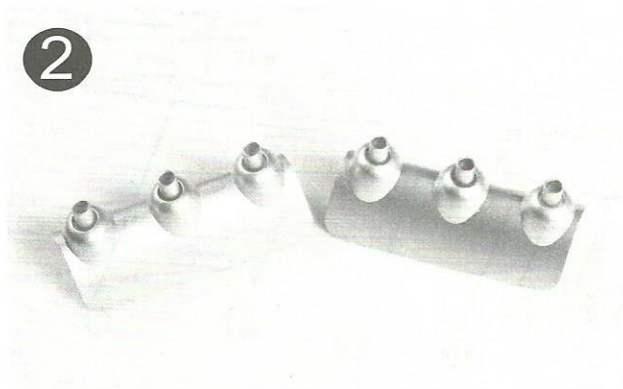

3. Position one of the gun set in to place, it will fit perfectly with the gun barrel toward straight forward. If not, you will have to change other one.

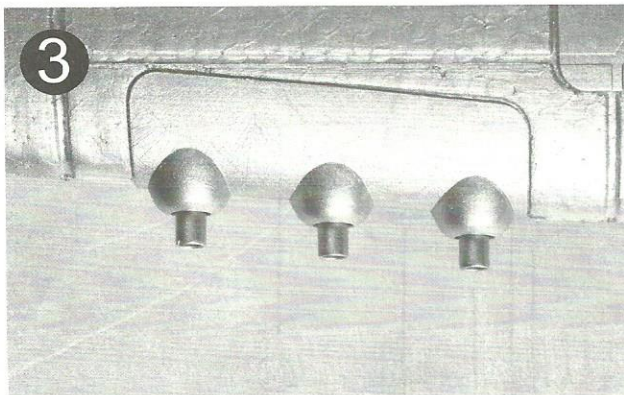

4. Take the set out and glue it back into place. Repeat the same steps for the other set install.

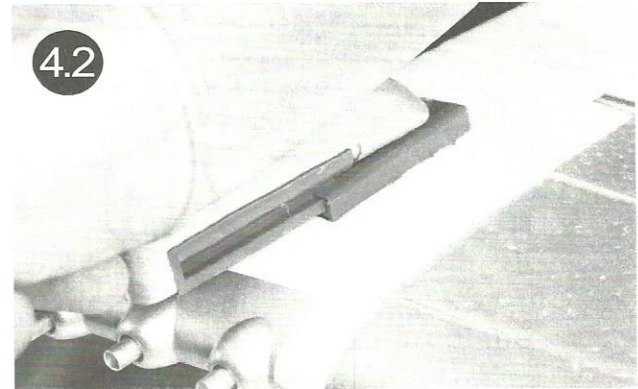
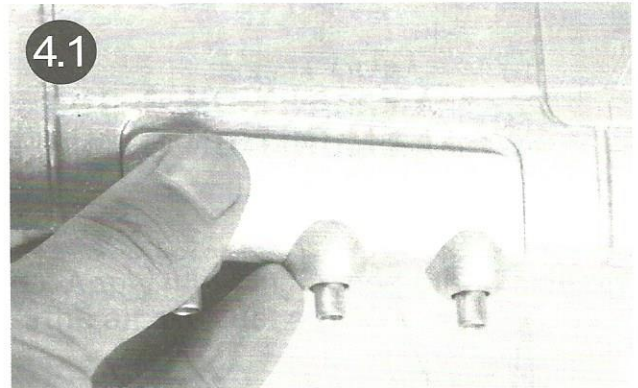

5. Hang on the oil tanks, two tanks are the same, you can take any one of them to hang on a rack.

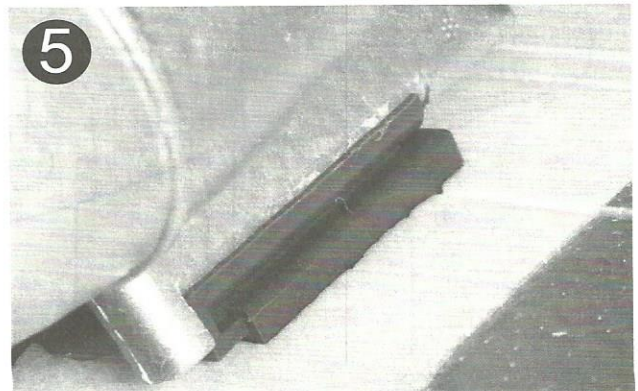

Maintenance mark applying instruction

Note: Please apply the maintenance mark details as the guiding illustrated pictures shows.

①	INSPINSPINSPINSPINSP	17	100 A 02 US GAL DR 72lbs BEFORE GRADE	18	GROUND HERE
②	MOORING RINGS MOORING RINGS	19	COOLANT DRAIN		
③	JACK JACK JACK JACK HERE HERE HERE HERE	19B	STEP HERE	STEP HERE	
④	REMOVE FOR GROUND HEATER DUCT	19A	COOLANT VENT AFTER COOLANT VENT	COOLANT VENT AFTER COOLANT VENT	
⑤	OIL DRAIN	20	OXYGEN FILTER INSTRUCTIONS INSIDE		
⑥	REMOVE FOR GROUND HEATER DUCT		LIFT CAUTION		
⑦	CAMERA ACCESS		LIFT CAUTION		
⑧	AMMUNITION 8 GUN ACCESS				

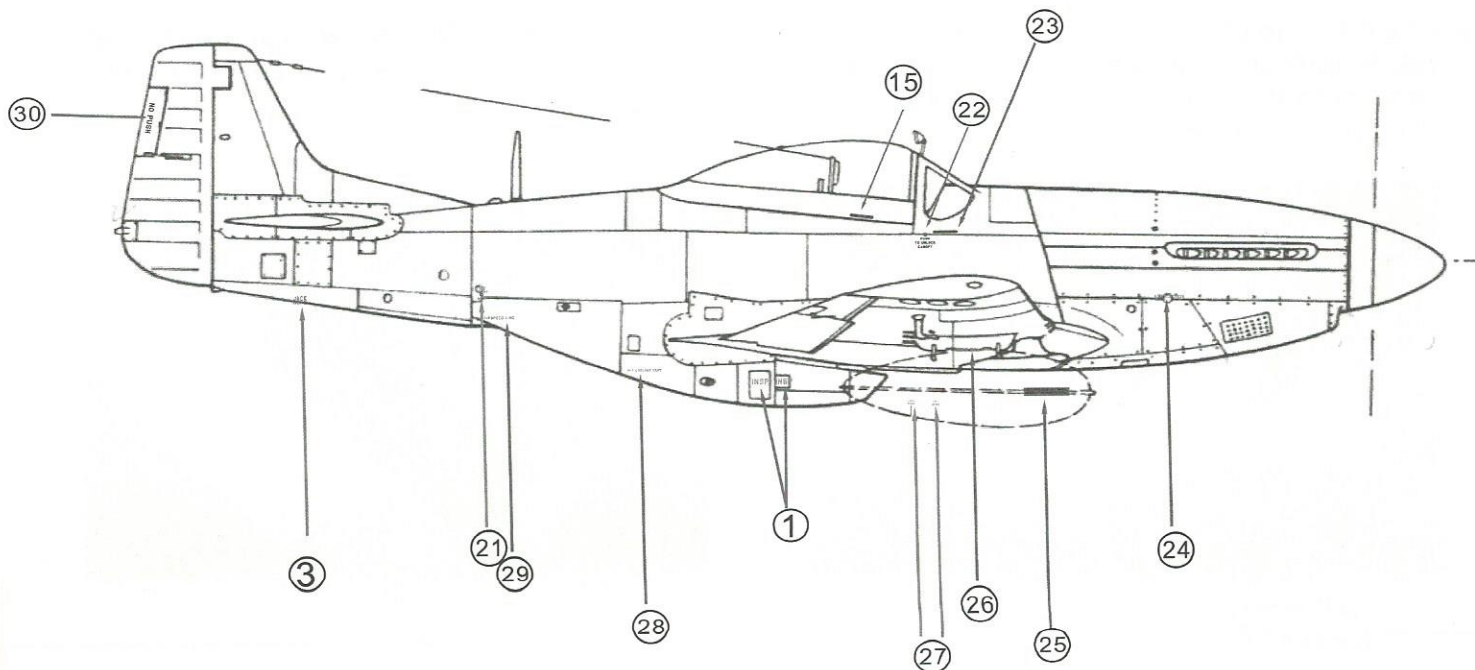
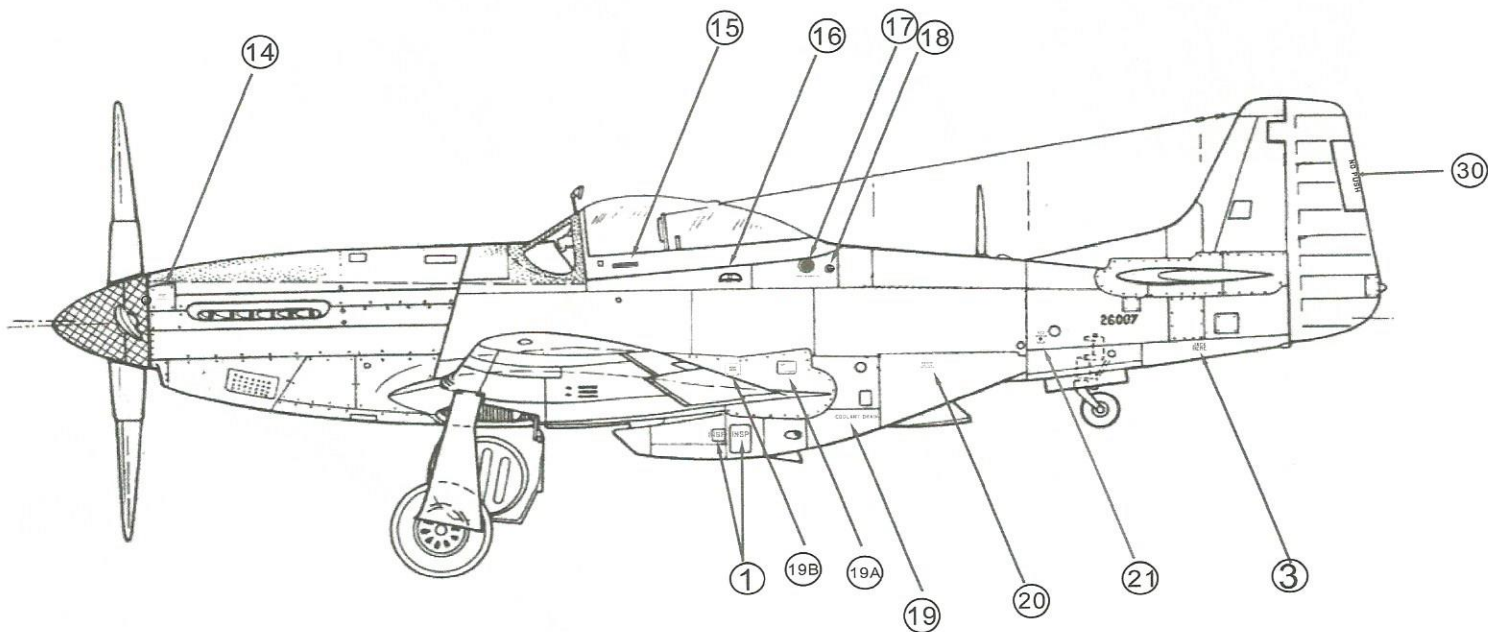

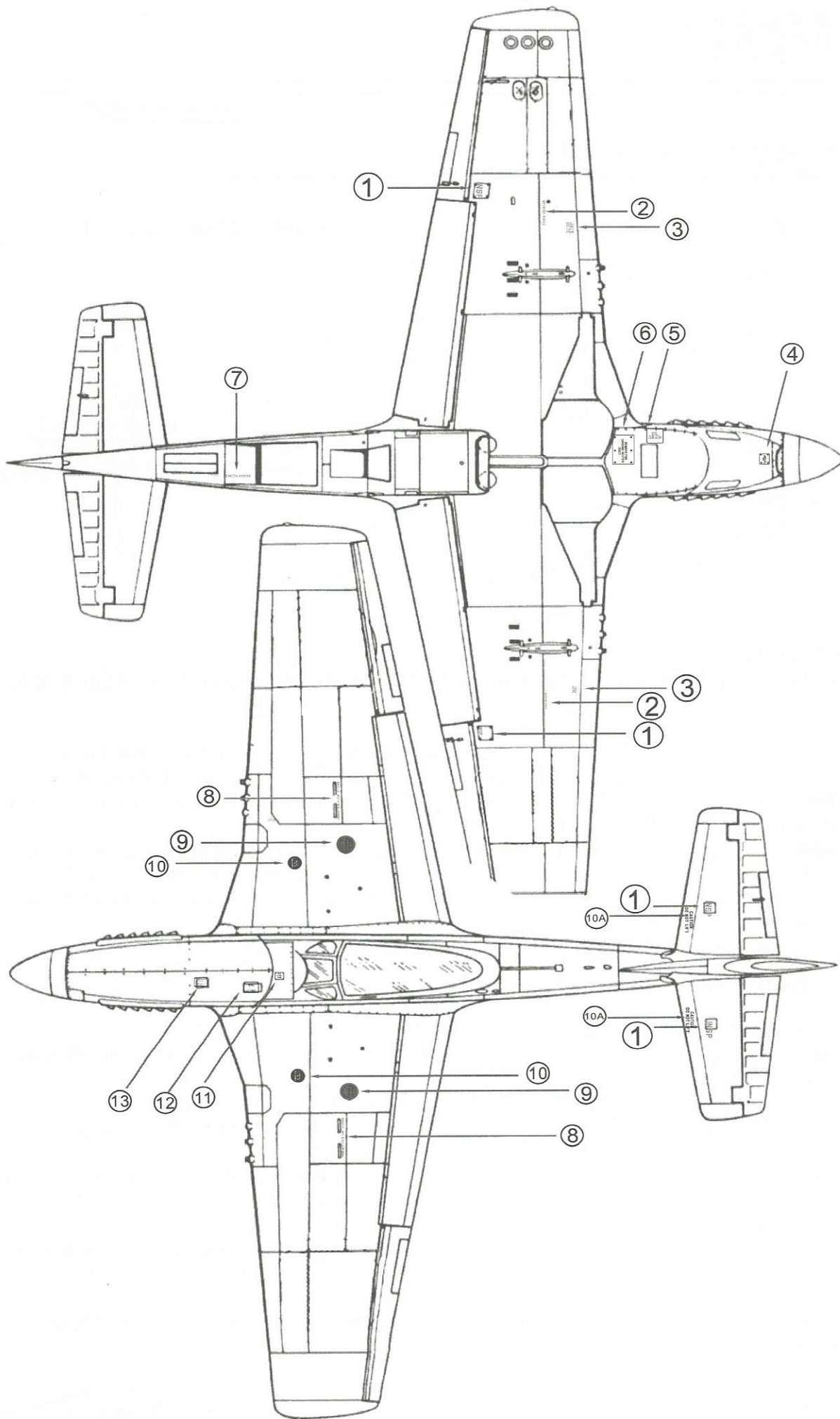

Main specification

Specification

Wingspan	: 1450mm /57.0in
Length	: 1240mm /49.0 in
Weight	: 2050g /72.3 oz
CG Position	: 110mm (From the leading edge of the main wing)
Battery	: 14.8V 2600mAh Li-Po Battery
ESC	: 70A
Motor	: 4250-KV 540
Wing Area	: 38.7dm ²
Wing Load	: 52.9g/dm ²
RC System	: 6 Channel, 9 Servos And 1 Brushless ESC

Center Of Gravity(C.G.)

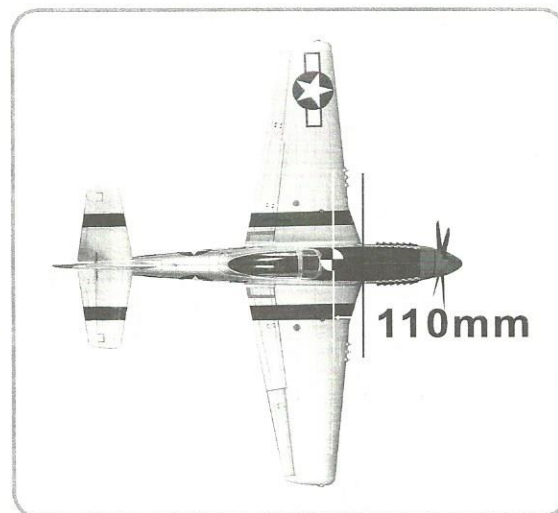

Center of Gravity

When balancing your model, adjust the motor battery as necessary so the model is level or slightly nose down.

This is the correct balance point for your model.

After the first flights, The **CG** position can be adjusted for your personal preference.

1. The recommended Center of Gravity(**CG**) location for your model is (110mm/4.3in) back from the leading edge of the top main wing as shown with the battery pack installed. Mark the location of the **CG** on top of the wing.
2. When balancing your model, support the plane inverted at the marks made on the top of the main wing with your fingers or a commercially available balancing stand. This is the correct balance point for your model, Make sure the model is assembled and ready for flight before balancing.

Note: Always balance the plane with the retracts down.

Control throw setting

1. Turn on the transmitter and receiver of your model.
check the movement of the rudder using the transmitter.
When the stick is moved right, the rudder should also move right. Reverse the direction of the servo at the transmitter if necessary.
2. Check the movement of the elevator with the radio system.
Moving the elevator stick toward the bottom of the transmitter makes the airplane elevator move up.
3. Check the movement of the ailerons with the radio system, moving the aileron stick right makes the right aileron move up and left aileron move down.
4. Use a ruler to adjust the throw of the elevator, aileron and rudder.
Adjust the position of the pushrod at the control horn and the transmitter to achieve the suggested throws (listed on next page) when moving the transmitter sticks to their end points.

Note: Always disassemble the propeller set when binding the transmitter and testing the control surface.

Main specification and spare parts

The suggested throws for the **FMS P51** are as follows:

	High rate	Low rate
Elevator -	40mm/1.6in up and down	24mm/0.9in up and down
Rudder -	25mm/0.98in left and right	21mm/0.8in left and right
Ailerons -	28mm/1.1in up and down	17mm/0.7in up and down
Flaps -	Mid 22mm/0.9in Full 45mm/1.8in	

Spare parts list

Item#	Description
SU-101	Fuselage
SU-102	Main wing (A pair of wing with the gear base installed)
SU-103	Vertical stabilizer
SU-104	Horizontal stabilizer
SU-105	Cockpit (Foam cockpit hatch)
SU-106	Canopy (Plastic canopy)
SU-107	Windshield
SU-108	Oil tank (A pair of identical oil tank)
SU-109	Rear landing gear hatch fairing door(Two pieces)
SU-110	Machine gun set (Starboard and port side machine gun)
SU-111	Air cooling intake
SU-112	Wing bolt plate (Two pieces: Front and the rear plate)
SU-113	Motor board
SU-114	Cowl
SU-115	Propeller (Four pieces blade)
SU-116	Spinner
SU-117	Main landing gear system (A pair of retracts with strut and wheel installed)
SU-118	Main landing gear strut (A pair of main landing gear struts with the wheels installed)
SU-120	Rear landing gear system
SU-127	Aluminum motor base (With four pieces sink head screw)
SU-128	Motor shaft
SU-129	Linkage rod (All of the control surface linkage rod with clevis installed)
SU-130	Screw set
SU-131	Decal sheet
SU-132	Detailed decal sheet
SU-133	Tire set (A pair of main strut tires and a rear landing gear tire)
SU-134	The inner fairing door
SU-135	The outer fairing door
SU-136	Pipe
SU-137	Battery Tray
SU-138	Multiple Connector Part 1 (For the wing panels)
SU-139	Multiple Connector Part 2 (For plug to receiver)
SU-140	exhaust pipe
FMS-Motor	(4250-KV540)
FMS-ESC-70A	with5A SBEC
FMS-9g-Positive	slow servo flaps
FMS-9g-metal gear	servo reverse
FMS-9g-metal gear	servo positive
FMS-9g-metal gear	servo positive 54 DEGREE
FMS-17g-metal gear	servo
FMS-Sequencer-6 sec	P51
FMS-Retract 003	

Note: 1. All spare parts without decals.

2. The Item# without color marking could be applied universally for all **FMS** color schemes.

Spare Parts List

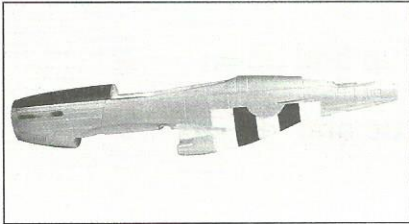

SU-101

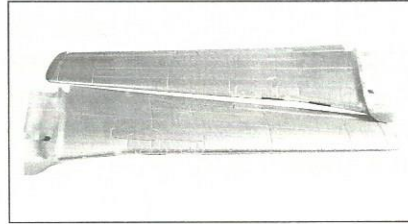

SU-102

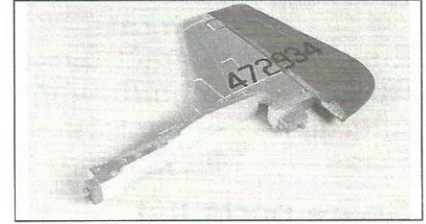

SU-103

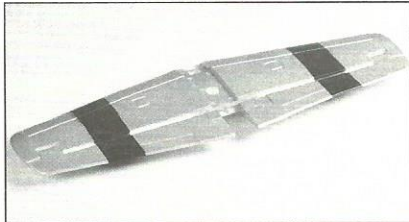

SU-104

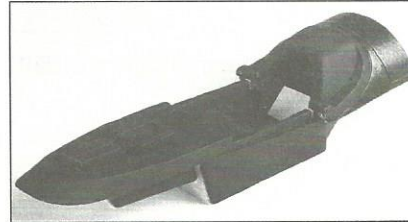

SU-105

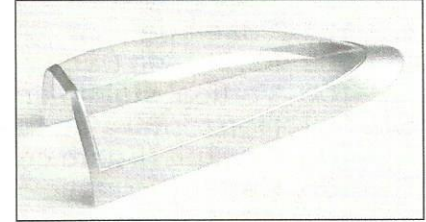

SU-106

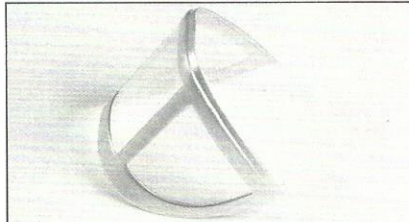

SU-107

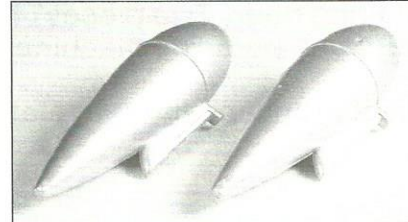

SU-108

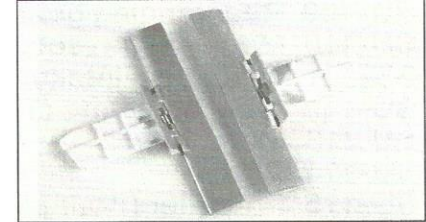

SU-109

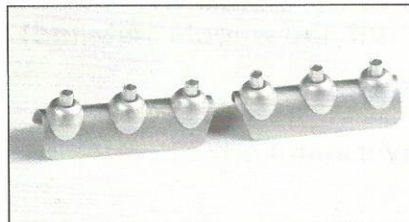

SU-110

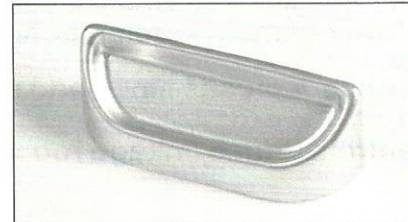

SU-111

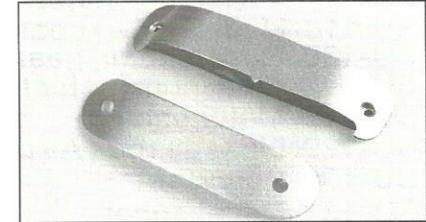

SU-112

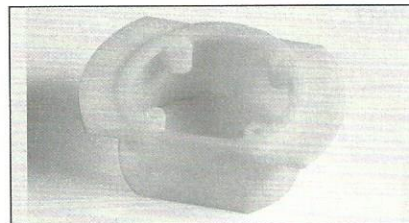

SU-113

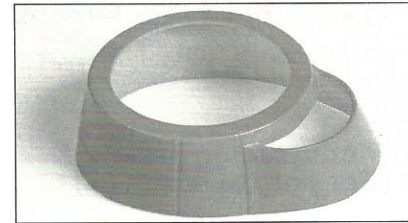

SU-114

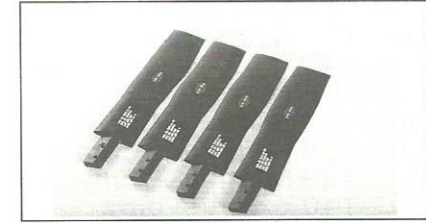

SU-115

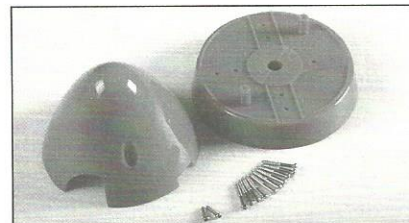

SU-116

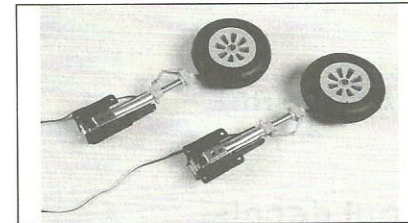

SU-117

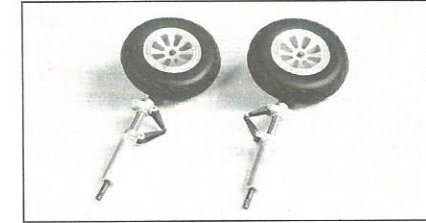

SU-118

Spare Parts List

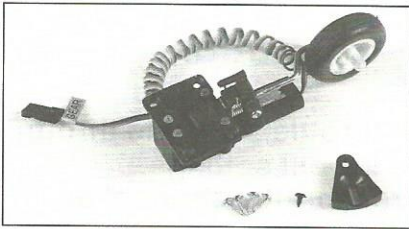

SU-120

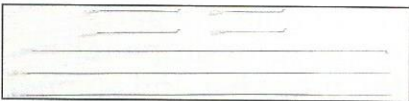

SU-129



SU-130



SU-135



SU-136



FMS-Motor (4250-KV540)

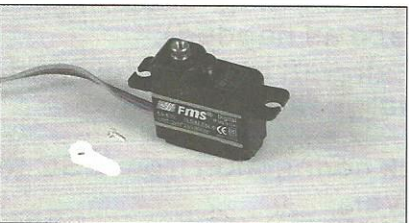

FMSSER9MGR

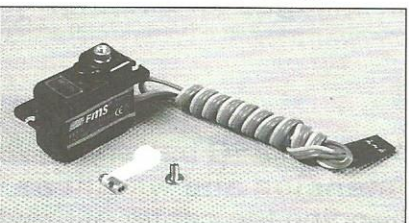

FMSSER17MG

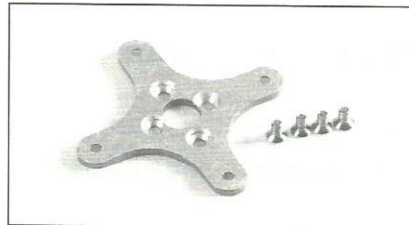

SU-127



SU-131



SU-132



SU-137



SU-138



FMS-ESC-70A 5A SBEC
(200mm length cable)



FMSSER9MGP

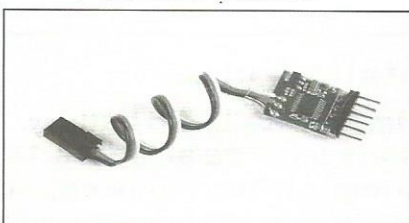

FMS-Sequencer-6 sec P51



SU-128



SU-133

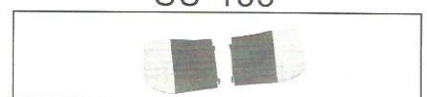

SU-134

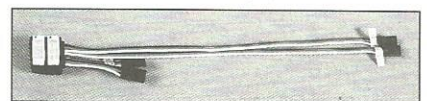

SU-139

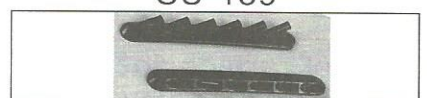

SU-140

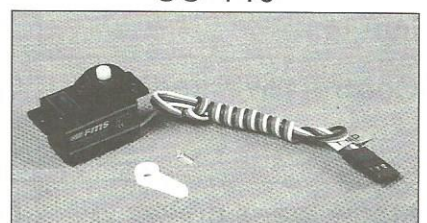

FMSSER9SLP



FMSSER9MG-54deg

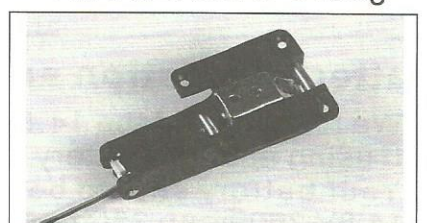

FMS-Retract 003

Troubleshooting

Problem	Possible Cause	Solution
Aircraft will not respond to the throttle but responds to other controls.	ESC is not armed. Throttle channel is reversed.	Lower throttle stick and throttle trim to lowest settings. Reverse throttle channel on transmitter.
Extra propeller noise or extra Vibration.	Damaged spinner, propeller, motor or motor mount. Loose propeller and spinner parts. Propellor installed backwards.	Replaced damaged parts. Tighten parts for propeller adapter, propeller and spinner.
Reduced flight time or aircraft underpowered.	Flight battery charge is low. Propeller installed backward. Flight battery damaged.	Remove and install propeller correctly. Completely recharge Flight battery. Replace flight battery and obey flight battery instructions.
Control surface does not move, or is slow to respond to control inputs.	Control surface, control horn, linkage or servo damage, Wire damaged or connections loose.	Replace or repair damaged parts and adjust controls. Do a check of connections for loose wiring.
Control reversed.	Channels need be reversed in the transmitter.	Do the Control Direction Test and adjust controls for aircraft and transmitter.
Motor loses power. Motor power pulses then motor loses power.	Damage to motor, or battery. Loss of power to aircraft. ESC uses default soft Low Voltage Cutoff(LVC).	Do a check of batteries, transmitter, receiver, ESC, motor and wiring for damage (replace as needed). Land aircraft immediately and Recharge flight battery.
LED on receiver flashes slowly.	Power loss to receiver.	Check connection from ESC to receiver. Check servos for damage. Check linkages for binding.

Battery Selection and Installation.

1. We recommend the 14.8V 2600mAh 25C Li-Po battery.
2. If using another battery, the battery must be at least a 14.8V 2600mAh 25C battery.
3. Your battery should be approximately the same capacity, dimension and weight as the 14.8V 2600mAh 25C Li-Po battery to fit in the fuselage without changing the center of gravity a large amount.

Range Check Your Radio System

After final assembly, range check the radio system with the **FMS P51**. Refer to your specific transmitter instruction manual for range test information .

Take off and landing tips

1. Take off using full power, as soon as you have taken off retract the landing gear.
2. Use the flaps to give a steeper landing approach, increase throttle slightly to offset the increased drag.
3. Ensure that you set a timer and land with plenty of battery power in reserve.
4. It is difficult to land the plane perfectly from a high speed flight when the flaps are in the up position.
5. Never exceed 3 minutes of continuous full power flight.
6. Never exceed the limited flying weight.

First Flight Preparation

1. Remove and inspect contents.
2. Charge flight battery.
3. Read this instruction manual thoroughly.
4. Fully assemble model.
5. Install the flight battery in the aircraft (once it has been fully charged).
6. Bind aircraft to your transmitter.
7. Make sure linkages move freely.
8. Make sure the rubber ring has been properly slide on the clevis.
9. Perform the Control Direction Test with the transmitter.
10. Adjust light controls and transmitter.
11. Perform a radio system Range Check.
12. Find a safe and open area.

Please read the following instructions and fully understand it.

1. Do not fly in strong wind or bad weather.
2. Never fly the model in crowded areas, where there are lots of people, automobiles on the road or power lines overhead . Also do not to fly around the airport. Please make yourself enough room for the flying and operating, as the plane can travel at high speed. Remember you are responsible for the safety of others.
3. Children under the age of 12 should have an adult guide. Never recommend for the children under the age of 14.
4. Never leave the charger in wet conditions.
5. The **P51** is made from PA and polythene which are tinder. When it meets the heat, transfiguration can easily happen, so you must keep it away from heat.
6. Do not attempt to catch the **P51** while flying, please do not touch the propeller.
7. Never leave this system unattended around children with battery in the unit, as injury may be caused due to children's turning on the transmitter or the plane.
8. During the preparation for the flight, please remember to turn on the transmitter before connecting the battery pack.
9. Close the throttle on the transmitter before connecting battery otherwise the motor may operate.

AMA

If you are not already a member of the AMA, please join, The AMA is the governing body of model aviation and membership provided liability insurance coverage, protects modelers' rights and interests and is required to fly at most R/C sites.

Academy of Model Aeronautics

5151 East Memorial Drive

Muncie, IN 47302-9252

Ph.(800)435-9262

Fax(765)741-0057

Or via the Internet at: <http://www.modelaircraft.org>



Academy of Model Aeronautics National Model Aircraft Safety Code Effective January 1, 2011

- A. GENERAL:** A model aircraft is a non-human-carrying aircraft capable of sustained flight in the atmosphere. It may not exceed limitations of this code and is intended exclusively for sport, recreation and/or competition.
All model flights must be conducted in accordance with this safety code and any additional rules specific to the flying site.
1. Model aircraft will not be flown:
 - (a) In a careless or reckless manner.
 - (b) At a location where model aircraft activities are prohibited.
 2. Model aircraft pilots will:
 - (a) Yield the right of way to all man carrying aircraft.
 - (b) See and avoid all aircraft and a spotter must be used when appropriate.
(AMA Document #540-D-See and Avoid Guidance.)
 - (c) Not fly higher than approximately 400 feet above ground level within three (3) miles of an airport, without notifying the airport operator.
 - (d) Not interfere with operations and traffic patterns at any airport, heliport or seaplane base except where there is a mixed use agreement.
 - (e) Ensure the aircraft is identified with the name and address or AMA number of the owner on the inside or affixed to the outside of the model aircraft.
(This does not apply to model aircraft flown indoors).
 - (f) Not operate aircraft with metal-blade propellers or with gaseous boosts except for helicopters operated under the provisions of AMA Document #555.
 - (g) Not operate model aircraft while under the influence of alcohol or while using any drug which could adversely affect the pilot's ability to safely control the model.
 - (h) Not operate model aircraft carrying pyrotechnic devices which explode or burn, or any device which propels a projectile or drops any object that creates a hazard to persons or property.

Exceptions:

- ◆ Free Flight fuses or devices that burn producing smoke and are securely attached to the model aircraft during flight.
 - ◆ Officially designated AMA Air Show Teams (AST) are authorized to use devices and practices as defined within the Team AMA Program Document (AMA Document #718).
3. Model aircraft will not be flown in AMA sanctioned events, air shows or model demonstrations unless:
- (a) The aircraft, control system and pilot skills have successfully demonstrated all maneuvers intended or anticipated prior to the specific event.
 - (b) An inexperienced pilot is assisted by an experienced pilot.
4. When and where required by rule, helmets must be properly worn and fastened. They must be OSHA, DOT, ANSI, SNELL or NOCSAE approved or comply with comparable standards.

B. RADIO CONTROL (RC)

1. All pilots shall avoid flying directly over unprotected people, vessels, vehicles or structures and shall avoid endangerment of life and property of others.
2. A successful radio equipment ground-range check in accordance with manufacturer's recommendations will be completed before the first flight of a new or repaired model aircraft.
3. RC model aircraft must use the radio-control frequencies currently allowed by the Federal Communications Commission (FCC). Only individuals properly licensed by the FCC are authorized to operate equipment on Amateur Band frequencies.
4. RC model aircraft will not operate within three (3) miles of any pre-existing flying site without a frequency-management agreement (AMA Documents #922-Testing for RF Interference; #923- Frequency Management Agreement)
5. With the exception of events flown under official AMA Competition Regulations, excluding takeoff and landing, no powered model may be flown outdoors closer than 25 feet to any individual, except for the pilot and the pilot's helper(s) located at the flight line.
6. Under no circumstances may a pilot or other person touch a model aircraft in flight while it is still under power, except to divert it from striking an individual. This does not apply to model aircraft flown indoors.
7. RC night flying requires a lighting system providing the pilot with a clear view of the model's attitude and orientation at all times.
8. The pilot of a RC model aircraft shall:
 - (a) Maintain control during the entire flight, maintaining visual contact without enhancement other than by corrective lenses prescribed for the pilot.
 - (b) Fly using the assistance of a camera or First-Person View (FPV) only in accordance with the procedures outlined in AMA Document #550.

C. FREE FLIGHT

1. Must be at least 100 feet downwind of spectators and automobile parking when the model aircraft is launched.
2. Launch area must be clear of all individuals except mechanics, officials, and other fliers.
3. An effective device will be used to extinguish any fuse on the model aircraft after the fuse has completed its function.

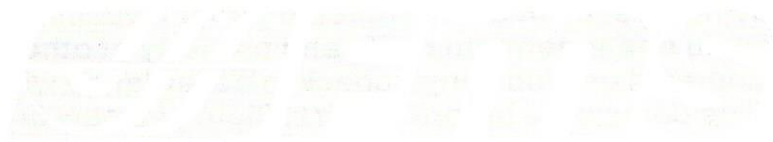

Email: info@fmsmodel.com
Http: // www.fmsmodel.com

MADE IN CHINA