

Operating Manual

PRODIGY612
DUAL AC/DC

Professional Balance Charger



CH1

ESC
MODE

◀DEC

INC▶

START
ENTER

CH2

PROTEKRC

PRODIGY612
DUAL AC/DC

Prodigy 612 DUO AC/DC

Operating Manual

TABLE OF CONTENTS

1	Special Features.....	01
2	Specifications.....	02
3	Key Functions.....	02
4	Warning & Safety Notes.....	02
5	Exterior.....	03
6	Programming Guide.....	05
7	Operating Instructions.....	06
8	Warning & Error Messages.....	14
9	After-Sale Service & Guarantee.....	15
10	Safety Messages.....	15

1 Special Features

- Advanced design and programming creates a stable charging environment, helping to reduce potential problems caused by negligence or setting errors by the user.
- Compatible with LiPo, Li-Ion, LiFe, NiMH, NiCd, & Pb batteries.
- Individual cell voltage balancer maintains the balance between cells within $\pm 0.01V$ tolerance during the charging and discharging process.
- Performs from 1 to 5 continuous cycles of charge→discharge, or discharge→charge for NiMH/NiCd batteries.
- Set the battery capacity in the menu, and the charger will automatically set the current to a 1C rate.
- Discharge cut-off voltage can be adjusted from 3.0V to 4.0V per cell.
- Digital Power converts the input power to an output power of 3.0V to 24.0V to power other electronic equipment.
- Outside temperature monitor function and USB communication function can be used at the same time.
- Screen Backlight Saver: The backlight can be set to automatically disable itself. The time can be adjusted from 0 to 10 minutes.
- The total battery voltage and battery cell voltage can be displayed by pressing and holding the **INC** or **DEC** key for more than 3 seconds.
- Pre-Charge function helps to restore batteries that have been discharged below the low voltage point.

2 Specifications

AC Input Voltage Range: AC 110V or 220V
DC Input Voltage Range: DC 11.0V – 18.0V
Charge Current Range: 0.1 – 12.0A
Discharge Current Range: 0.1 – 5.0A
Charge Power Limit: Max 100W x2
Discharge Power Limit: Max. 20W x2
Balance Current: Max. 250mA
Balance Tolerance: $\pm 0.01V$

NiCd/NiMH Battery Cell Count: 1 – 16 Cells
Lithium Battery Types: LiPo, Li-Ion, LiFe
Lithium Battery Cell Count: 1 – 6 Cells
Pb Battery Voltage: 2 – 20V
Digital Power: 3 – 24V
Weight: 1250g
Dimensions: 208x170x63mm

3 Key Functions

Independent “CH1/CH2” Keys: Channel Select buttons. Press the “CH1” key to switch to Channel 1, and press the “CH2” key to switch to Channel 2.

“ESC/MODE” Key: Mode selection/stop/back button. Press this key to go back to the main menu and to stop the charge/discharge process.

“DEC/INC” Keys: Reduce and increase buttons. When you are setting parameters, use the DEC button to reduce the value and the INC key to increase the value. The INC key is also used to browse other information during the charge/discharge process.

“START/ENTER” Key: Use the Start/Enter button to start a function by pressing and holding the key for more than 2 seconds.

4 Warning & Safety Notes

WARNING: Read the ENTIRE instruction manual to become familiar with the features of the product before operating. Failure to operate the product correctly can result in damage to the product and personal property, and cause serious injury.



WARNING: Failure to exercise caution while using this product and comply with the following warnings could result in product malfunction, electrical issues, excessive heat, FIRE and ultimately injury and property damage.

- Never leave this product unattended during use.
- Never attempt to charge dead, damaged or wet battery packs.
- Never attempt to charge a battery pack containing different types of batteries.
- Never allow minors to charge battery packs.
- Never charge batteries in an extremely hot or cold environment, or place in direct sunlight.
- Never charge a battery if the cable has been pinched or shorted.
- Never connect more than one battery pack to a single channel of this charger at one time.
- Never connect the charger if the power cable has been pinched or shorted.

- Never connect the charger to an automobile battery while the vehicle is running.
- Never attempt to dismantle the charger or use a damaged charger.
- Never reverse the positive and negative terminals.
- Never connect the input jack (DC Input) to AC power.
- Always use rechargeable batteries designed for use with this type of charger.
- Always inspect the battery before charging.
- Always keep the battery away from any material that could be affected by heat.
- Always monitor the charging area and have a fire extinguisher available at all times.
- Always end the charging process if the battery becomes hot to the touch or starts to change form (swell) during the charge process.
- Always charge Lithium batteries in a LiPo safe charging sack.
- Always connect the charge cable to the charger first then connect the battery to avoid a short circuit between the charge leads. Reverse this sequence when disconnecting.
- Always connect the positive red leads (+) and negative black leads (-) correctly.
- Always disconnect the battery after charging, and let the charger cool between charges.



WARNING: Never leave the charger unattended, exceed the maximum charge rate, charge with non-approved batteries or charge batteries in the wrong mode. Failure to comply may result in excessive heat, fire and serious injury.



CAUTION: Always ensure the battery you are charging meets the specifications of this charger and that the charger settings are correct. Not doing so can result in excessive heat and other related malfunction, which can lead to user injury or property damage.

5 Exterior

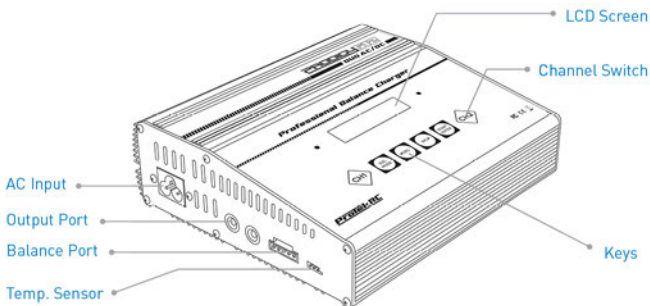

5 Exterior (cont...)

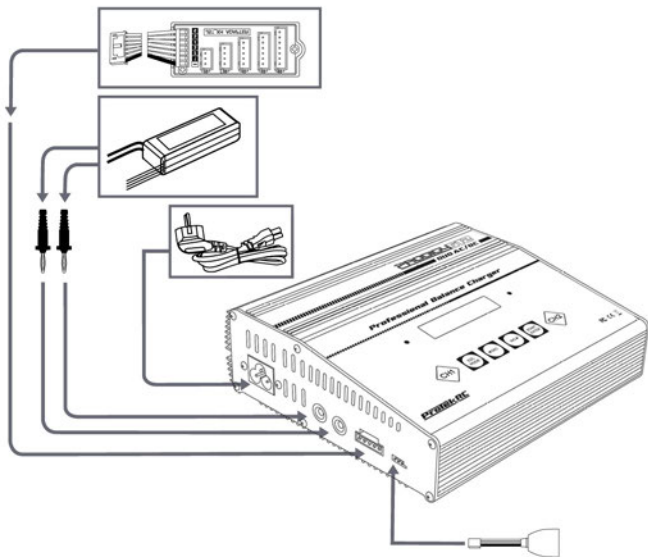

CAUTION: Always power on the charger before connecting a battery to the charger, or damage to the charger and the battery can result.

- 1 Connect power cord to power source.
- 2 Make program selection in the charger for the battery that is going to be charged.
- 3 Connect the charge cable to the charger.
- 4 Connect battery to charge cable (connect main charging connectors before connection cell-balancing connectors, when used).
- 5 Start battery charging.

7 Operating Instructions

7.1.1 Main Menu

The Main Menu shows the charger model for 2 seconds during the start up/self check process. The charger will then transition to the default LiPo balance charge mode. If this is the desired charge mode, press **START/ENTER** in the main menu and adjust the values as needed for the battery that is going to be charged. If the battery type or other function needs to be changed, press the **ESC/MODE** button to alter the program.

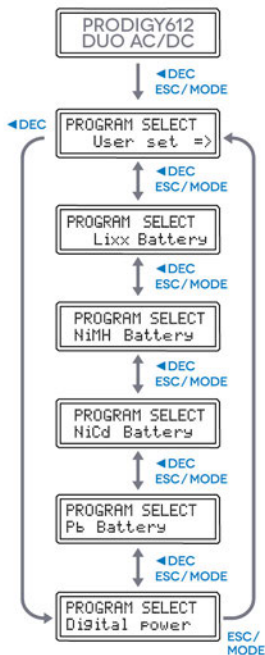

Program Select. Press the **ESC/MODE** key to cycle down through the program menu or the Dec key to cycle up through the menu. Press the **START/ENTER** key to transfer to the submenu within the chosen program, and press the **ESC/MODE** key to exit the submenu.

FROM THE PROGRAM SELECT MENU, CHOOSE:

Lithium Battery Program. This mode is used with LiPo, LiFe and Li-Ion batteries.

NiMH Battery Program. This mode is used with Nickel Metal Hydride batteries.

NiCd Battery Program. This mode is used with Nickel Cadmium batteries.

Pb Battery Program. This mode is used with lead acid batteries.

Tunable Digital Power Mode. This mode allows the user to channel the input power from the charger and deliver 3.0V to 24V of output power for various DC devices.

7.2 Initial Parameter Setup

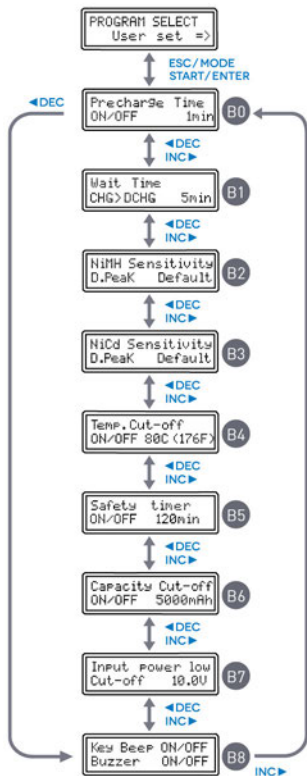

Verify that the charger parameters have been setup correctly in the "User Set" menu before starting a charge or discharge process.

Press the **ESC/MODE** key to cycle through the menu until the "User Set" screen is displayed. Press the **START/ENTER** key to enter into the parameter setting menu. The user can then move between the channel menus by pressing the **DEC/INC** keys. Please refer to the flow chart at the left.

When the user is ready to change the parameter value in the program, press the **START/ENTER** key to make it blink, then change the value with the **DEC/INC** key. The value will be stored by pressing the **START/ENTER** key once.

The charger is compatible with three types of Lithium batteries, LiPo, Li-Ion and LiFe. The user **MUST** verify that the charger is set to match the battery that is going to be charged, or it could cause a fire and/or explosion. (Please refer to Chart A on page 8).

This charger can automatically recognize the cell count of a Lithium battery. If the battery voltage is lower than the lowest safety voltage level, the charger will not start the charge process. This is when the user could use the Pre-Charge function to restore the voltage of the battery. The restore time (normally 2 minutes) can be changed in the **B0** menu. The higher the battery capacity, the more time it will need.

NOTE: The Pre-Charge function must be turned off when using the normal charge mode. Additionally, **DO NOT** use this function unless the condition of the battery is known to be stable. When using the Pre-Charge function, the user must monitor the battery voltage closely. If the voltage does not increase quickly, stop the Pre-Charge process immediately or it could result in FIRE and ultimately injury and property damage.

When a NiMH or NiCd battery is in a charge/discharge cycle process, the battery may become warm. The charger programming allows you to set a delay time from 1 to 60 minutes to give the battery time to cool before being subjected to the next process (See screen **B1**).

B2 / **B3** shows the delta peak sensitivity voltage (ΔV) for automatic charge termination of NiMH and NiCd batteries. The effective value ranges from 5 to 20mV per cell. If the ΔV is set too high, there is a risk of overcharging the battery; if it is set too low, there is a possibility the battery will not be fully charged. Please refer to the technical specifications of the battery manufacturer. (NiCd: 12mV, NiMH: 7mV)

NOTE: If the voltage of the charging battery is lower than 2.5V, the ΔV may not be perceived. This will cause a risk of discharge. Use a temperature sensor or set the charge current above 1C to avoid it.

The temperature sensor port is the 3-pin port on the side of the charger and is labeled "Temp.". This port is used with an optional temperature sensor and will read the maximum safety temperature set by the user (see screen **B4**). The charger will then monitor the battery temperature via the temperature sensor and will terminate the process if the temperature value is exceeded.

When a charge process is started, the internal safety timer automatically starts running at the same time. This is programmed to prevent overcharge of the battery if the battery is faulty or if the termination circuit cannot detect that the battery is full. This program can be on or off (see **B5**) and the user can set the maximum safety time. This value ranges from 10 to 720 minutes. There is also a maximum capacity limit value, ranging from 100 to 25000mAh (see **B6**).

When a 12V DC automobile battery is used to supply power to the charger, screen **B7** shows the voltage input of the DC battery. If the DC battery voltage drops below the value set by the user, the operation will be terminated to protect the input battery. Screen **B8** is where the user can set the alert and key tones.

NOTE: Please refer to Chart A below to select the correct values for each battery type. Failure to select the correct settings could result in product malfunction, electrical issues, excessive heat, FIRE and ultimately injury and property damage.

CHART A

Interm \ Types	Li-Po	Li-Io	Li-Fe	NiMH	NiCD	Pb
Standard Voltage (V/cell)	3.70	3.60	3.30	1.20	1.20	2.00
Max. Charge Voltage Cutoff Level (V/cell)	4.20	4.10	3.60	1.60	1.60	2.45
Allowable Fast Current	<1C	<1C	<4C	<2C	<2C	<0.4C
Min. Discharge Voltage Cutoff Level (V/cell)	>3.00	>3.00	>2.00	>1.00	>0.85	>1.75

7.3 Lithium Battery Programming

Press **ESC/MODE** key in the screen on the left until the correct Lithium battery type has been selected, then press **START/ENTER** key to enter into the parameter setting menu. The user can switch between the charge modes in the menu using the **DEC/INC** key. Please refer to the flow chart on the left. To alter the parameter value in the program, press the **START/ENTER** key to make it blink, then change the value with the **DEC/INC** key. The value will be stored by pressing **START/ENTER** once. Then press and hold the **START/ENTER** key for more than two seconds to start the process.

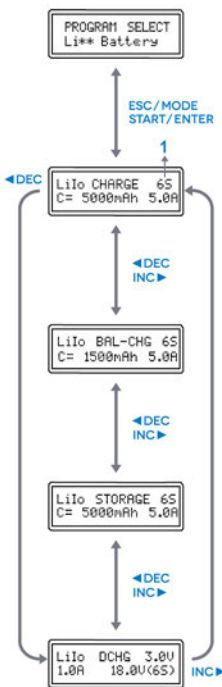

Charge Mode. Use for an individual battery or a battery pack without a balance connector or cell count. 1 shows the cell count. C= shows the capacity of the battery pack. NOTE: The charger will automatically set the charge current at a 1C rate according to the capacity of the battery. If you charge a high rate battery pack you can set the current value a little higher.

Balance Charge Mode. Use with 2-6 cell Lithium batteries that have a balance plug. The battery pack being charged should be connected to a balance board that is connected to the port on the side of the charger (see picture B on page 10). In this mode the charger's internal processor will monitor and control the voltage of each cell in the battery pack using an optimized calculation to control the voltage range within a tolerance of $\pm 0.01V$. This helps to improve the discharge performance of the battery.

Storage Mode. Use to condition batteries for storage. This mode will adjust the voltage of the battery as needed in order to set the voltage to 40%. The final voltage may differ depending on the type of battery [Li-Ion: 3.75V, LiPo: 3.85V, LiFe: 3.3V]. When this mode is selected, the charger will determine if the battery needs to be charged or discharged for storage. If the voltage of the battery at its initial stage is over the storage voltage level, the program will discharge the pack; if it is higher the program will charge the pack. When using this mode, the user must connect both the primary connector and the balance plug.

Discharge Mode. This is typically not used with Lithium batteries. To avoid an over-discharge condition when using discharge mode, it is recommended that the user set the discharge cut-off voltage to 3.0-4.0V and connect the balance plug of the battery to the charger.

Connection diagram in the balance charging/storage/discharge mode

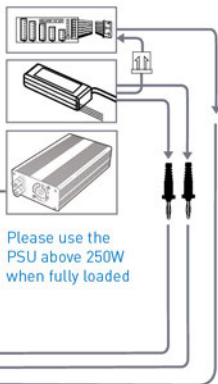
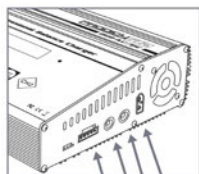

7.3.1 Start the Charge/Discharge Process:

After the parameters have been correctly setup in the mode menu, press and hold the **START/ENTER** key for more than two seconds to start the process.

This screen shows the number of cells that have been selected, and that the processor detects. "R" shows the number of cells found by the charger and "S" is the number of cells chosen by the user in the previous menu. If both numbers are identical, the process can be started by pressing the **START/ENTER** button. If these values are not identical, press the **ESC/MODE** button to go back to the previous menu. Carefully verify the number of cells in the battery pack. If the auto or discharge modes have been selected, ignore this screen.

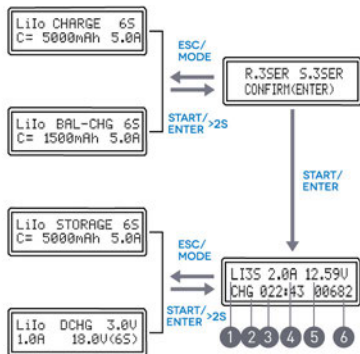

This screen shows the current condition during the charge process. To stop charging, press **ESC/MODE** key once. As shown in the image on the left, ① shows the cell count, ② shows the operating mode [CHG=charging in auto mode, BAL=balance charging mode, FAS=fast charging mode, STO=storage mode, DSC=discharge mode], ③ shows the elapsed time, ④ shows the charge/discharge current, ⑤ shows the charge/discharge voltage of the battery, ⑥ shows the capacity of the charge/discharge.

7.3.2 Enter the Lithium Battery mode

Before the charge/discharge process has started, the user can press and hold the **INC** or **DEC** key for more than two seconds to display the individual cell voltage, as well as the Input Voltage (Power Supply), and Output Voltage (Battery). The user must press the **ESC/MODE** key to exit these menus.

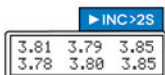

Hold the **INC** key for more than two seconds to display the individual cell voltage before the process has been started. Press the **ESC/MODE** key to exit.

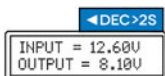

Hold the **DEC** key for more than two seconds to display the input and output voltage before the process has been started. Press the **ESC/MODE** key to exit.

During a charge/discharge process, pressing the **INC** and **DEC** keys will display:

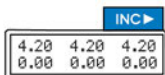

The individual voltage of each cell in the battery when using the balance plug.



The End Voltage that will be reached at the end of the process.



The user set Capacity Cut Off limit.



The user set Safety Timer.

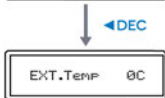

The external temperature when a temperature sensor is used. The user can see the inner/external temperature when the temperature sensor is connected.

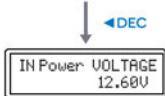

The present Input Power voltage.

7.4 NiMH/NiCd Battery Programming

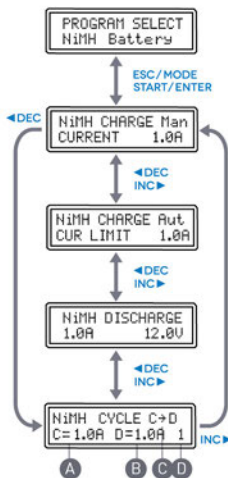

- A Charge current in the cycle mode
- B Discharge current in the cycle mode
- C Sequence to cycle
- D Number of cycles

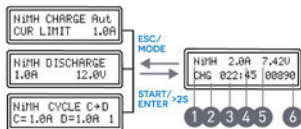

shows the elapsed time; 4 shows the charge/discharge current; 5 shows the voltage of the battery; 6 shows capacity of the charge/discharge. The preset parameters, including temperature and ΔV , can be viewed at any time by pressing the DEC/INC keys.

Press the **ESC/MODE** key while in the screen shown on the left, then press the **START/ENTER** key to enter the submenu. The user can switch within the menu to select the mode by pressing the **DEC/INC** key. Refer to the flow chart at the left. When ready to edit a parameter value in the program, press the **START/ENTER** key to make it blink, then change the value using the **DEC/INC** key. The value will be stored by pressing the **START/ENTER** key. Then press and hold the **START/ENTER** key for more than two seconds to start the charge process.

NOTE: The NiMH and NiCd menu are the same and the NiMH example is shown at the left.

CHARGE Mode: The default is "Aut". In "Aut" mode, the user will need to set the upper limit of the charge current to avoid a current level that could damage the battery. The processor may incorrectly identify some batteries with low impedance and low capacity, and may be set to a higher than recommended charge current when in "Aut" charge mode. It is recommended that these batteries be charged in "Man" mode. Manual mode allows the user to select a charge current that is sufficient for the battery type. Switch between modes by pressing the **START/ENTER** key for more than one second when the current field is blinking.

DISCHARGE Mode: This mode allows the user to select a discharge current range from 0.1A to 5.0A, with a final voltage range of 0.1 to 25V. The final voltage of a NiMH battery is 1.0V per cell, while a NiCd battery is 0.85V per cell. Please refer to the battery manufacturer for recommended low voltage cut off.

CYCLE Mode: This can be set from 1 to 5 cycles of continuous discharge→charge or charge→discharge. This is useful for both new and used Nickel chemistry cells. This parameter must be setup correctly to prevent damaging the cells. Follow the previous charge/discharge menu to set these parameters.

After the modes have been checked, press and hold the **START/ENTER** key for more than two seconds.

This screen displays the present state of the process. To stop the process, press the **ESC/MODE** key. 1 shows the type of battery; 2 shows the operating mode (CHG=charge, DSC=discharge, DCHG→CHG or CHG→DCHG=cycle mode); 3

7.5 Pb Battery Programming

This is programmed for charging Pb batteries with a nominal voltage from 2 to 20V. Pb batteries cannot be charged rapidly. The optimal charge current should be 1/10th of the battery capacity. Please follow the battery manufacturer's instructions when setting up the charge parameters.

7.5.1 Charging Pb Battery

Pb	CHARGE
4.0A	12.0V(6P)

As shown on the left, the charge current is shown on the left side of the second line, and the voltage of the battery is shown on the right side of the second line. The charge current can be set from 0.1 to 10.0A and should be matched to the battery being charged. Start the charge process by pressing and holding the **START/ENTER** key for more than two seconds.

ESC/
MODE

START/
ENTER >2S

Pb-6	4.0A	12.59V
CHG	022:43	00602

This screen displays the state of the charging process. To force the charge to stop, press the **ESC/MODE** key once.

7.5.2 Discharging Pb Battery

Pb	DISCHARGE
4.0A	12.0V(6P)

Set the discharge current shown on the left side of the second line, and the final voltage on the right side of the second line. The discharge current ranges from 0.1 to 5.0A and the cut off voltage should be matched with the battery being discharged. Start the discharge process by pressing and holding the **START/ENTER** key for more than two seconds.

ESC/
MODE

START/
ENTER >2S

Pb-6	0.4A	12.59V
DSC	022:43	00602

Displays the current state of discharge.

7.6 Digital Power Program

PROGRAM SELECT
Digital Power

In this mode, the charger can provide an output power of DC 3.0V to 24V to power other electronic equipment.

ESC/
MODE

START/
ENTER

POWER MODE
2.0A 12.0V

ESC/
MODE

START/
ENTER >2S

CURRENT	2.00A
VOLTAGE	12.0V

8 Warning & Error Messages

- REVERSE POLARITY** → **Reverse Polarity:** The output is connected to a battery with incorrect polarity.
- CONNECTION BREAK** → **Connection Break:** This is displayed when the charger detects a connection interruption between the battery and charge lead, or when the charge lead is disconnected during operation.
- SHORT ERROR** → **Short Error:** There is a short circuit at the charge leads.
- INPUT VOL ERR** → **Input Vol Err:** The voltage of the input power has dropped below the limit.
- VOL SELECT ERR** → **Vol Select Err:** The Lithium battery pack voltage was selected incorrectly. Verify the voltage of the battery carefully.
- BREAK DOWN** → **Break Down:** There has been a malfunction within the charger circuit.
- BATTERY CHECK LOW VOLTAGE** → **Battery Check Low Voltage:** The processor detects the voltage is lower than what is set in the Lithium program. Check the cell count of the battery.
- BATTERY CHECK HIGH VOLTAGE** → **Battery Check High Voltage:** The processor detects the voltage is higher than what is set in the Lithium program. Check the cell count of the battery.
- BATTERY VOLTAGE CELL LOW VOL** → **Battery Voltage Cell Low Vol:** The voltage of one of the cells in the Lithium battery pack is too low. Check the voltage of each individual cell within the battery pack.
- BATTERY VOLTAGE CELL HIGH VOL** → **Battery Voltage Cell High Vol:** The voltage of one of the cells in the Lithium battery pack is too high. Check the voltage of each individual cell within the battery pack.
- BATTERY VOL ERR CELL CONNECT** → **Battery Vol Err Cell Connect:** There is a bad connection at the connector. Check the connector and cables carefully.
- TEMP OVER ERR** → **Temp Over Err:** The internal temperature of the charger is too high. Let the charger cool down.
- CONTROL FAILURE** → **Control Failure:** The processor cannot continue to control the feeding current. The unit needs to be repaired.

9 After-Sale Service & Guarantee

ProTek R/C guarantees this item to be free of defects in materials and workmanship for one (1) year after original purchase date. The warranty only applies to material or operational defects that are present at the time of purchase; ProTek R/C reserves the right to repair or replace the item.

Warranty will not cover items that have been modified, disassembled, or otherwise misused according to the item's instructions. Proof of purchase is required to submit a warranty claim. ProTek R/C is not responsible for bodily injury and/or property damage that may occur from the use of, or caused by, this item.

10 Safety Messages

IMPORTANT:

- 1 Do not cover the charger during use.
- 2 Do not use or store in an environment below 41°F [5°C] or above 122° [50°C].
- 3 Use the charger carefully and do not operate it in a wet or corrosive environment.
- 4 Do not drop, strike, or shake the charger, and do not place heavy items on the charger.
- 5 Never disassemble the charger.
- 6 Keep the charger away from children and pets at all times.
- 7 Never leave a battery in your model while charging
- 8 Never leave power supply, charger or battery unattended during charging
- 9 Never exceed maximum charge rate
- 10 Never charge with incompatible batteries
- 11 Never charge batteries in wrong mode
- 12 Never over discharge a Lithium battery
- 13 Never charge a damaged or swollen battery
- 14 Never charge near or on flammable materials
- 15 Always ensure proper polarity of plugs
- 16 Always balance charge a LiPo battery
- 17 Always use a LiPo charging bag
- 18 Always use a LiPo specific charger to charge a LiPo
(NiMH or NiCd only chargers WILL NOT WORK!)



Warning: This product contains chemicals known to the State of California to cause cancer, birth defects or other reproductive harm.



THIS PRODUCT IS NOT A TOY! NOT FOR CHILDREN UNDER 14 YEARS.
For proper operation and to avoid risk of damage and injury, read and follow all instructions before operating this product. Failure to comply may result in excessive heat, fire, property damage and serious injury.

Compliance Information for the European Union

Declaration of Conformity



Product(s): ProTek R/C 612 DUO AC Battery Balance Charger
Item Number(s): PTK-8510

The object of declaration described above is in conformity with the requirements of the specifications listed below, following the provision of the European EMC Directive 2004/108/EC

EN 55014-1:2006
EN 55014-2:1997+A1:2001
EN 61000-3-2:2006
EN 61000-3-3:2008

Instructions for disposal of WEEE by users in the European Union



This product must not be disposed of with other waste. Instead, it is the user's responsibility to dispose of their waste equipment by handing it over to a designated collections point for the recycling of waste electrical and electronic equipment. The separate collection and recycling of your waste equipment at the time of disposal will help to conserve natural resources and ensure that it is recycled in a manner that protects human health and the environment.

All rights including translation reserved. Reproduction of this manual by any method, including photocopy, microfilming, or the capture in electronic data processing system require the prior written approval of ProTek R/C. Reprinting in any way is prohibited. These operating instructions represent the technical status at the time of printing. ProTek R/C reserves the right to make changes to the technology and equipments.